



IMPORTANT! Remove this guide before giving the device to the patient. Only medical professionals should adjust pressure settings.

This guide provides you with instructions on how to access and navigate the provider screens used to modify device settings. Refer to the *User Manual* for more information.

Note: The screens shown throughout this guide are examples only. Actual screens may vary slightly.

Accessing the Provider Mode Screens

Accessing provider mode unlocks settings that cannot be modified by the user. To access provider mode:

1. Supply power to the device. First, plug the socket end of the AC power cord into the power supply. Then plug the pronged end of the AC power cord into an electrical outlet that is not controlled by a wall switch. Finally, plug the power supply cord's connector into the power inlet on the back of the device.
2. Once the device is powered, the Home screen appears, shown below. Turn the control wheel to toggle between the four options and highlight "Setup".

Therapy	Flex
Info	Setup

Home Screen

Note: "Flex" shown above will display as the current Flex mode.

3. Once "Setup" is highlighted, press and hold both the control wheel and the Ramp button  on the device for at least 5 seconds.
4. You will hear a quick double beep and the Provider mode screen will appear, shown below. You are now in provider mode.

EXIT	Reminder
Info	Setup

Provider Screen

Navigating the Provider Mode Screens

To navigate these display screens:

Turn the control wheel to toggle between options and settings on the screen. Press the control wheel to choose an option or setting that is highlighted. If you choose “Back” on any screen, it will take you back to the previous screen.

Note: Choosing “EXIT” from the Provider screen will exit provider mode and the device will return to the Home screen in the patient mode.

Note: Provider mode will time out after 1 minute of inactivity and automatically exit the provider mode and return to the Home screen in the patient mode.

Provider Mode Screen Descriptions

The following sections will describe the options available under the 3 choices from the Provider screen (Reminder, Setup, and Info).

Reminder Screen

From the Provider screen, highlight “Reminder” and press the control wheel. The following Reminder screen will appear.

Reminder	Back
	Reminder off 30 90
	180 270 365

Reminder Screen

- **Reminder** - You can set a reminder on this screen that will let patients know when it is time to perform a certain task, such as replacing the mask. You can select one of the following settings: Off (no reminder is set), or you can set the device to display a reminder after 90, 180, 270, or 365 days.

Note: You can set a specific patient reminder message using the EncorePro software, and put this message on the SD card or send it to the patient’s device via a modem.



Setup Screen

From the Provider screen, highlight “Setup” and press the control wheel. The following Setup screen will appear.

Setup	Back	
	Mode	Auto CPAP
	Auto max	(auto min) - 20.0
	Auto min	4.0 - (auto max)
	CPAP pres	4.0 - 20.0
	Flex type	C-Flex (C-Flex+)or(A-Flex) None
	Flex	1 2 3
	Ramp time	0:00 - 0:45
	Ramp start	4.0 - (auto min)or(CPAP pres)
	Tubing type lock	on off
	Tubing type	15 22 15H
	SYSTEM ONE resistance	0 X1 X2 X3 X4 X5
	Lock SYSTEM ONE	on off
	Heated Tube humidification	on off
	SYSTEM ONE humidification	on off
	Humidifier	0 1 2 3 4 5
	Humidity level	1 2 3
	Tube temperature	0 1 2 3 4 5
	Auto on	on off
	Auto off	on off
	Mask alert	on off
	Mask fit check	on off
	Humidifier LED Backlight	on off
	Show AHI/leak/PB	on off
	Split night	on off
	Split night start	
	Silent mode	on off
	Language	EN ES
	Back	

Setup Screen

Note: The screen will only show a few lines at a time. As you rotate the control wheel to toggle over different options the screen will slide up and down accordingly. If the text is too long to completely fit on the screen, it will scroll horizontally across the screen when highlighted.

- **Mode** - This screen displays the therapy mode setting. You can select CPAP therapy or Auto-CPAP therapy. CPAP therapy provides one level of output pressure for both the inspiratory and expiratory breathing phases. Auto-CPAP therapy provides CPAP therapy while automatically adjusting the pressure level when apnea, hypopnea, flow limitation, or snoring events are detected.
Note: The menu options will vary between CPAP mode and Auto-CPAP mode.
- **Auto max** - This screen allows you to modify the Auto Maximum pressure setting. The setting you specify here will be the maximum pressure for the device. Auto therapy will adjust the CPAP pressure between the Auto Maximum and the Auto Minimum pressure settings.
Note: This screen only displays if Auto-CPAP therapy is enabled.
- **Auto min** - This screen allows you to modify the Auto Minimum pressure setting. The setting specified here will be the minimum pressure for the device. Auto therapy will adjust the CPAP pressure between the Auto Maximum and the Auto Minimum pressure settings.
Note: This screen only displays if Auto-CPAP therapy is enabled.
- **CPAP pres** - This screen displays the current CPAP pressure setting. You can adjust the setting from 4 cm H₂O to 20 cm H₂O.
Note: This screen only displays if CPAP therapy is enabled.
- **Flex type** - This screen displays the comfort mode setting. You can select None, C-Flex, or C-Flex+ (if in CPAP mode). You can select None, C-Flex, or A-Flex (if in Auto-CPAP mode).
- **Flex** - You can modify the Flex setting (1, 2 or 3) on this screen if you enabled Flex. The setting of “1” provides a small amount of pressure relief, with higher numbers providing additional relief.
Note: The patient also has access to this setting, if Flex is enabled.
- **Ramp time** - When you set the Ramp time, the device increases the CPAP pressure from the value set on the Ramp start screen to either the CPAP pressure setting (if in CPAP mode) or the Auto Minimum pressure setting (if in Auto-CPAP mode) over the length of time specified here.
Note: If the CPAP pressure (if in CPAP mode) or Auto Minimum pressure (if in Auto-CPAP mode) is set to 4 (the minimum setting), this screen will not display.
Note: If the Ramp time is set to 0, Ramp start will not display.
- **Ramp start** - This displays the Ramp starting pressure. You can increase or decrease the Ramp starting pressure in 0.5 cm H₂O increments. This is only available if Ramp time has been set to >0 and auto min or CPAP pressure >4 cm H₂O. This will not display if Split night is enabled.
- **Tubing type lock** - This enables you to lock the Tubing type setting for either the 15 mm or the 22 mm tubing if you do not want the patient to change it.
Note: If locked, the patient will still see this setting with a lock symbol () next to it, but they will not be able to change it.
Note: This will not prevent the user from using Heated Tubing at a later date.
- **Tubing type** - This setting allows you to select the correct size diameter tubing that you are using with the device. You can choose either (22) for the Philips Respironics 22 mm tubing, or (15) for the optional Philips Respironics 15 mm tubing. When using Heated Tubing, the device will automatically change this setting to the appropriate tubing type (15H).
Note: If the Heated Tubing is removed, the device will default back to the previous tubing type setting.
- **SYSTEM ONE resistance** () - This setting allows you to adjust the level of air pressure relief based on the specific Philips Respironics mask. Each Philips Respironics mask may have a “System One” resistance control setting. System One resistance compensation can be turned off by choosing the setting “0”.
Note: The patient also has access to this setting, if Lock SYSTEM ONE is off.

- **Lock SYSTEM ONE** - This enables you to lock the “System One” resistance control setting if you do not want the patient to change it.
Note: If you lock this setting, the patient will see a lock symbol () next to the setting.
- **Heated Tube humidification** - This setting will only display if you are using the heated tube. You can enable or disable this feature.
- **SYSTEM ONE humidification** - System One humidity control maintains a consistent mask humidity by monitoring and adjusting for changes in room temperature and room humidity. You can enable or disable this feature. If the System One humidity control has been disabled, the classic style of basic temperature controlled heated humidification will be used. This will only display if the humidifier is attached.
- **Humidifier** - This setting allows you to choose the desired humidity setting: 0, 1, 2, 3, 4 or 5. If the System One humidity control has been disabled, the classic style of basic temperature controlled heated humidification will be used and the display will show: 0, C1, C2, C3, C4 or C5 for these settings. This will only display if the humidifier is attached. Please refer to the humidifier manual if using a humidifier.
Note: When not using Heated Tubing, the control wheel can also be used to change this setting.
- **Humidity level** - This setting will only display if you are using the heated tube. This setting allows you to choose the desired humidity setting for the humidifier: 1, 2 or 3. This setting can only be changed from the Setup screen.
- **Tube temperature** - This setting will only display if you are using the heated tube. This setting allows you to choose the desired temperature for the heated tube: 0, 1, 2, 3, 4 or 5. If you choose zero (0), this will turn off both the humidifier and the heated tube.
Note: When using Heated Tubing, the control wheel can also be used to change this setting.
- **Auto on** - You can enable or disable this feature if you want the device to automatically turn the airflow on whenever the patient applies the interface (mask) to their airway.
- **Auto off** - You can enable or disable this feature if you want the device to automatically turn the airflow off whenever the patient removes the interface (mask) from their airway.
- **Mask alert** - You can enable or disable the mask alert setting. If this feature is enabled, the mask alert will appear on the display screen when a significant mask leak is detected, and an audible alert will sound.
- **Mask fit check** - You can enable or disable the mask fit check setting if it is available on your device. If this feature is enabled, it allows the patient to check the fit of their mask prior to starting therapy. This is done by measuring the amount of leak in the patient circuit.
Note: This screen only displays if Auto-CPAP therapy is enabled.
Note: If Split night is enabled, Mask Fit Check will be disabled.
- **Humidifier LED Backlight (Ramp Backlight)** - You can enable or disable the LED backlight for the humidifier number settings and Ramp button on the device.
Note: If the humidifier is not attached, this feature will display as “Ramp Backlight” and control the LED backlight for the Ramp button only.
Note: If the Humidifier LED Backlight is enabled or disabled, the humidifier icon will always remain on (if humidifier is attached and heat is being applied), but will dim after 30 seconds of inactivity.
- **Show AHI/leak/PB** - You can select whether or not the Apnea/Hypopnea index, System Leak averages, and Periodic Breathing averages are displayed on the Patient Info screens.
- **Split night** - You can enable or disable Split Night on this screen, which splits the therapy throughout the night, first in CPAP therapy before transitioning to Auto-CPAP therapy.
Note: This screen only displays if Auto-CPAP therapy is enabled.
Note: If Split night is enabled, Ramp start will be disabled.

- **Split night start** - You can modify the Split night settings on this screen shown here.

Split night	Back	
	CPAP pres	(auto min)-(auto max)
	Duration	120 180 240
	Flex type	none C-Flex C-Flex+
	Flex	1 2 3
	Ramp time	0:00-0:45
	Ramp start	4.0-(CPAP pres)
	Back	

Split night settings

You can adjust the duration which is the amount of time spent in CPAP therapy before transitioning to Auto-CPAP therapy. You can set it to 120, 180, or 240 minutes. You can also adjust the CPAP pressure, Flex type, Flex setting, Ramp time, and Ramp starting pressure from this screen.

Note: This screen only displays if Split night is enabled and Auto-CPAP therapy is enabled.

Note: If Split night is enabled, Ramp start will be disabled.

- **Silent mode** - You can disable this feature if you want the device to emit an audible indicator (beep) during the following device operations: power on, therapy start, therapy stop, mask fit check, and humidifier preheat mode. The device defaults to the Silent mode being enabled, meaning the device does not emit a beep during these operations. The patient also has access to this feature.
- **Language** - This feature allows you to choose which language to display on the interface. You can choose English (EN), or Spanish (ES).

Info Screen

From the Provider screen, highlight “Info” and press the control wheel. The following Info screen will appear.

Info	Back
	Phone-in
	Compliance VIC
	Therapy hours
	Blower hours
	Days > 4
	Large leak
	AHI
	Periodic breathing
	90% pressure
	Reset data
	Machine hours
	Humidifier
	Back

Info Screen

Note: The screen will only show a few lines at a time. As you rotate the control wheel to toggle over different options the screen will slide up and down accordingly.

- **Phone-in** - This screen displays the total therapy hours for the device, the total blower hours, and the total number of days used when the sessions were greater than 4 hours since the device was last reset. This screen also displays a compliance check number you can use to validate that the data provided to you is the data taken from this screen.
- **Compliance VIC (Visual Inspection Check)** - This screen displays the start day and the total number of days used when the sessions were greater than 4 hours. This screen also displays a check code number you can use to validate that the data provided to you is the data taken from this screen.

- **Therapy hours** - The device is capable of recognizing the difference between the time the patient is actually receiving therapy and the time when the blower is simply running. This screen displays the average amount of time the patient is actually receiving therapy on the device over a 7 day and 30 day time frame (provided the device has at least 7 or 30 days of data respectively). If the device has only 5 days of data to use for the calculation, the 5 day average value will be seen under the 7 day display.
- **Blower hours** - This screen displays the number of hours that the blower has been active over the life of the device.
- **Days > 4** - This screen displays the cumulative number of device therapy sessions that exceeded 4 hours over a 7 day and 30 day time frame.
- **Large leak** - During any given night, the device recognizes the percentage of time the patient was experiencing what it deemed to be a large leak. Large leak is defined as the level of leak that is so large, it is no longer possible to determine respiratory events with statistical accuracy. This screen displays the average of these individual nightly values of percentage of time in large leak over a 7 day and 30 day time frame (provided the device has at least 7 or 30 days of data respectively). If the device has only 5 days of data to use for the calculation, the 5 day average value will be seen under the 7 day display.
- **AHI** - The device accumulates individual Apnea/Hypopnea indices (AHI) for each session the patient used the device. This screen displays the average of these individual nightly AHI values over a 7 day and 30 day time frame (provided the device has at least 7 or 30 days of data respectively). If the device has only 5 days of data to use for the calculation, the 5 day average value will be seen under the 7 day display.
- **Periodic Breathing** - During any given night, the device recognizes the percentage of time the patient was experiencing periodic breathing. This screen displays the average of these individual nightly values of periodic breathing over a 7 day and 30 day time frame (provided the device has at least 7 or 30 days of data respectively). If the device has only 5 days of data to use for the calculation, the 5 day average value will be seen under the 7 day display.
- **90% Pressure** - During any given night, the device recognizes the 90% Pressure achieved by the Auto Algorithm. 90% Pressure is defined as the pressure at which the device spent 90% of the session time at or below. For example, if the device recognized airflow for 10 hours, and 9 hours were spent at or below 11 cm H₂O, and 1 hour was spent above 11 cm H₂O, then the 90% Pressure would be 11 cm H₂O. This screen displays the average of these individual nightly values of 90% Pressure over a 7 day and 30 day time frame (provided the device has at least 7 or 30 days of data respectively). If the device has only 5 days of data to use for the calculation, the 5 day average value will be seen under the 7 day display. This screen only displays in Auto-CPAP therapy.
- **Reset data** - This screen allows you to erase all 7 and 30 day averages, compliance data, therapy hours and patient information on the device. Make sure that "Reset data" is highlighted on the info screen. Press and hold both the control wheel and the Ramp button  for at least 5 seconds. The device will beep once signifying that the data has been reset.
Note: Machine hours are not erased.
- **Machine hours** - This screen displays the amount of time that the machine has been active over the life of the device.
Note: Therapy hours and blower hours can be reset for new patients. Machine hours are not erased.
- **Humidifier** - This screen will display 3 settings: power supply (either the 60W or 80W), tubing type, and either humidifier or tube temperature setting (if using).

C-Flex Comfort Feature

The device consists of a special comfort feature called C-Flex. When C-Flex is enabled, it enhances patient comfort by providing pressure relief during the expiratory phase of breathing. In the diagram, the dashed line represents normal CPAP therapy in comparison to the bold line representing C-Flex. C-Flex levels of 1, 2, or 3 progressively reflect increased pressure relief.

C-Flex pressure relief is determined by the C-Flex setting and the amount of patient flow. C-Flex returns to the set pressure by the end of exhalation, when the airway is most vulnerable to closure.

Note: The patient also has access to this setting, if C-Flex is enabled.

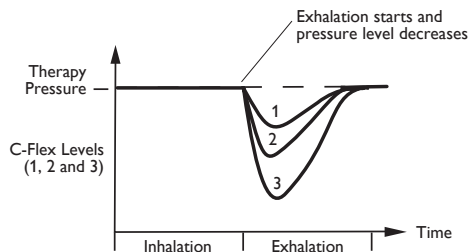

A-Flex (C-Flex+) Comfort Feature

The device consists of a special comfort feature called A-Flex if Auto-CPAP therapy is enabled (or C-Flex+ if CPAP therapy is enabled). When A-Flex (C-Flex+) is enabled, it enhances patient comfort in three ways: 1) by smoothing the transition between the end of inhalation and the beginning of exhalation, 2) by providing significant pressure relief during the beginning of exhalation, and 3) by reaching an end exhalation pressure of no more than 2 cm H₂O below the high point of inspiration.

In the diagram, the dashed line represents CPAP pressure in comparison to the bold line representing A-Flex (C-Flex+). A-Flex (C-Flex+) levels of 1, 2, or 3 progressively reflect increased pressure relief during the beginning of exhalation.

With A-Flex (C-Flex+), the level of pressure relief at the beginning of exhalation is determined by the A-Flex (C-Flex+) setting and the amount of patient flow in any one breath.

Note: The patient also has access to this setting, if A-Flex (C-Flex+) is enabled.

Note: A-Flex (C-Flex+) transitions from no A-Flex (C-Flex+) at 4.0 cm H₂O to full A-Flex (C-Flex+) at 6 cm H₂O. A-Flex (C-Flex+) is top limited at 20.0 cm H₂O pressure.

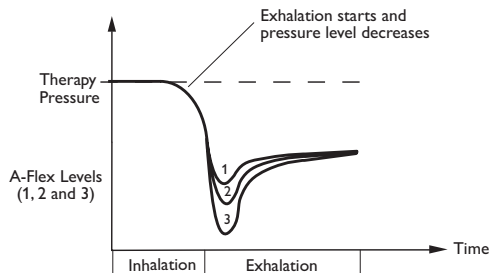

Ramp

The device is equipped with a linear Ramp feature that allows patients to reduce the pressure and then gradually increase (Ramp) the pressure to the prescription pressure setting so they can fall asleep more comfortably. The diagram illustrates how the Ramp feature works.

When the device is in Auto-CPAP therapy, pressing the Ramp button lowers the pressure level to the minimum Ramp pressure and then increases pressure in a linear fashion to the Auto minimum pressure setting over the set Ramp time. If patient events are detected during the Ramp, the Auto-CPAP algorithm will treat the events, and then continue to Ramp, as long as the device is not configured for split night therapy or the preset split night time period has expired during split night therapy. When the device is in Auto-CPAP therapy and ramp is disabled, pressing the Ramp button lowers the pressure level to the Auto minimum pressure setting, and resets the Auto-CPAP algorithm.

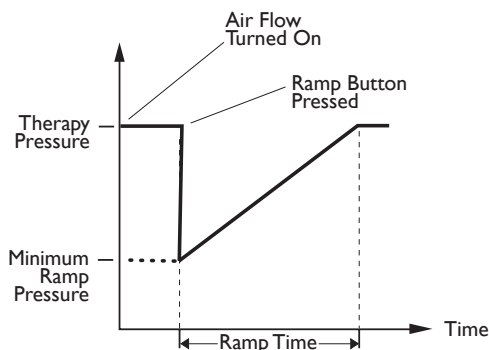

Event Definitions

The REMstar Auto A-Flex monitors breathing and detects apneas and hypopneas.

EVENT	Definition
Obstructed Airway Apnea / Clear Airway Apnea Detection	<p>An apnea is detected when there is an 80% reduction in airflow from baseline for at least 10 seconds or if there is no airflow detected for 10 seconds.</p> <p>During the apnea, one or more pressure test pulses are delivered by the device. The device evaluates the response of the patient to the test pulse(s) and assesses whether the apnea has occurred while the patient has a clear airway or an obstructed airway. The airway is determined to be clear if the pressure test pulse generates a significant amount of flow; otherwise the airway is determined to be obstructed.</p>
RERA Detection	<p>RERA (Respiratory effort-related arousal) is defined as an arousal from sleep that follows a 10 second or longer sequence of breaths that are characterized by increasing respiratory effort, but which does not meet criteria for an apnea or hypopnea. Snoring, though usually associated with this condition need not be present. The RERA algorithm monitors for a sequence of breaths that exhibit both a subtle reduction in airflow and progressive flow limitation. If this breath sequence is terminated by a sudden increase in airflow along with the absence of flow limitation, and the event does not meet the conditions for an apnea or hypopnea, a RERA is indicated.</p>
Periodic Breathing	<p>A persistent waning and waxing breathing pattern which repeats itself between 30 and 100 seconds. The nadir of the breathing pattern is characterized by at least a 40% reduction in airflow from an established baseline flow. The pattern must be present for several minutes before it can be identified as periodic breathing.</p> <p>No therapy adjustments are made in response to periodic breathing.</p>
Flow Limitation Detection	<p>The device looks for relative changes in the peak, flatness, roundness, or shape (skewness) of the inspiratory portion of the airflow waveform. These changes are observed both over a short period of time (groups of 4 breaths) and over a long period of time (several minutes). Statistical measures are used to help minimize false event detection while allowing the device to be sensitive to even small changes.</p>
Hypopnea Detection	<p>A hypopnea is detected when there is an approximately 40% reduction in airflow from baseline for at least 10 seconds.</p>
Snore Detection	<p>Vibratory snore is detected when a specific frequency is detected during the inspiratory portion of the patient's breath. Vibratory snore is disabled at pressures greater than 16 cm H₂O.</p>

Data Reset for Multiple Users

If you are using the device on multiple users, you must use the “Reset data” option available through the Info screen. Refer to the “Info Screen” section of this manual for additional information.

Cleaning for Multiple Users

WARNING: If you are using the device on multiple users, discard and replace the bacteria filter each time the device is used on a different person.

If you are using the device on multiple users, complete the following steps to clean the device before each new user.

1. Unplug the device before cleaning.
2. Clean the outside of the device only. Use a cloth with one of the following cleaning agents to clean the exterior of the device:
 - Mild Detergent
 - 70% Isopropyl Alcohol
 - DisCide Towelettes
 - 10% Chlorine Bleach solution
3. Allow the device to dry completely before plugging in the power cord.

Heated Humidifier Performance Confirmation

Humidifier preheat mode can be used to determine if the System One Heated Humidifier is working properly.

The following steps should be followed if there is a desire to confirm the performance of the System One Heated Humidifier.

WARNING: It is important to follow the exact steps below when performing this test in order to ensure no injury. Read all steps first before performing this test.

WARNING: Do not place your hand directly on the heater plate at any time during this test as it could result in a burn.

1. Disconnect the patient tubing (if attached) and remove the water tank.
2. While the therapy device is not running, place your hand above the heater plate (without touching it) to assess the temperature of the heater plate when off for later comparison.
3. Turn on humidifier preheat mode as described in the *User Manual*.
4. Allow the device to run in preheat mode for 30 seconds.
5. Place your hand above the heater plate (without touching it) to confirm an increase in heater plate temperature.
6. Press the control wheel while “Therapy” is highlighted on the Home screen to enter therapy and end preheat mode.
7. Press the control wheel again to turn off therapy.

Verifying the Pressure

WARNING: If the device fails to perform within the stated specifications, have the system serviced by a qualified Philips Respironics-approved service facility.

If part of your patient setup procedure is to verify actual pressure with a manometer, please use the following instructions to ensure that the device is functioning properly. You will need the following equipment to verify the pressure:

- Philips Respironics Pressure Calibration Kit

Kit Includes:

- Philips Respironics Whisper Swivel II
 - Philips Respironics O₂ Enrichment Final Assembly
 - Closed end cap
- Philips Respironics flexible tubing
 - Pressure tubing
 - Philips Respironics Digital Manometer or equivalent

Minimum Specifications:

0 - 25 cm H₂O (or better)

±0.3 cm H₂O accuracy

±0.1 cm H₂O resolution

- Foam filter

To verify the pressure, complete the following steps:

1. Install the foam filter into the back of the device.
2. With the device unplugged, connect the system as illustrated in the diagram.
3. Turn the manometer on. If it does not display a reading of zero, adjust the manometer to calibrate it. If the manometer has variable settings for devices, set it to cm H₂O.
4. Supply power to the device then place the device in provider mode.
5. Set the therapy parameters according to the patient specific data.
6. Set the device to the specific pressure value for the patient.
7. Verify that the pressure setting matches the pressure displayed on the manometer. If the pressure setting does not match the measured value for the device, contact Philips Respironics or an authorized service center to have the device serviced.

Note: Output pressures may vary at local altitude and barometric pressure. Because of these factors, devices may slightly vary in output pressure over the range of the altitude settings.

8. Set up the remaining parameters and exit provider mode. The unit is ready for patient use.

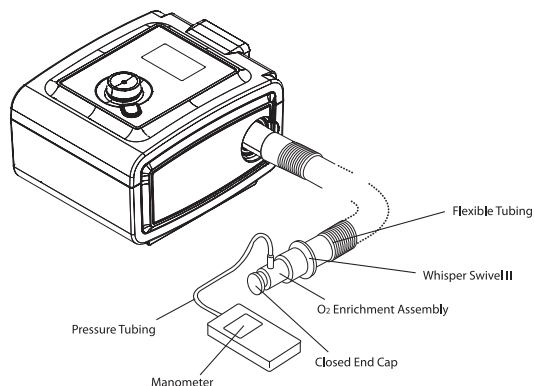

EMC Information

Guidance and Manufacturer's Declaration - Electromagnetic Emissions – This device is intended for use in the electromagnetic environment specified below. The user of this device should make sure it is used in such an environment.

EMISSIONS TEST	COMPLIANCE	ELECTROMAGNETIC ENVIRONMENT - GUIDANCE
RF emissions CISPR 11	Group 1	The device uses RF energy only for its internal function. Therefore, its RF emissions are very low and are not likely to cause any interference in nearby electronic equipment.
RF emissions CISPR 11	Class B	The device is suitable for use in all establishments, including domestic establishments and those directly connected to the public low-voltage power supply network.
Harmonic emissions IEC 61000-3-2	Class A	
Voltage fluctuations/Flicker emissions IEC 61000-3-3	Complies	

Guidance and Manufacturer's Declaration - Electromagnetic Immunity – This device is intended for use in the electromagnetic environment specified below. The user of this device should make sure it is used in such an environment.

IMMUNITY TEST	IEC 60601 TEST LEVEL	COMPLIANCE LEVEL	ELECTROMAGNETIC ENVIRONMENT - GUIDANCE
Electrostatic Discharge (ESD) IEC 61000-4-2	±6 kV contact ±8 kV air	±6 kV contact ±8 kV air	Floors should be wood, concrete or ceramic tile. If floors are covered with synthetic material, the relative humidity should be at least 30%.
Electrical fast Transient/burst IEC 61000-4-4	±2 kV for power supply lines ±1 kV for input-output lines	±2 kV for supply mains ±1 kV for input/output lines	Mains power quality should be that of a typical home or hospital environment.
Surge IEC 61000-4-5	±1 kV differential mode ±2 kV common mode	±1 kV differential mode ±2 kV for common mode	Mains power quality should be that of a typical home or hospital environment.
Voltage dips, short interruptions and voltage variations on power supply input lines IEC 61000-4-11	<5% U_T (>95% dip in U_T) for 0.5 cycle 40% U_T (60% dip in U_T) for 5 cycles 70% U_T (30% dip in U_T) for 25 cycles <5% U_T (>95% dip in U_T) for 5 sec	<5% U_T (>95% dip in U_T) for 0.5 cycle 40% U_T (60% dip in U_T) for 5 cycles 70% U_T (30% dip in U_T) for 25 cycles <5% U_T (>95% dip in U_T) for 5 sec	Mains power quality should be that of a typical home or hospital environment. If the user of the device requires continued operation during power mains interruptions, it is recommended that the device be powered from an uninterruptible power supply or a battery.
Power frequency (50/60 Hz) magnetic field IEC 61000-4-8	3 A/m	3 A/m	Power frequency magnetic fields should be at levels characteristic of a typical location in a typical hospital or home environment.

NOTE: U_T is the a.c. mains voltage prior to application of the test level.

Guidance and Manufacturer's Declaration - Electromagnetic Immunity – This device is intended for use in the electromagnetic environment specified below. The user of this device should make sure it is used in such an environment.

IMMUNITY TEST	IEC 60601 TEST LEVEL	COMPLIANCE LEVEL	ELECTROMAGNETIC ENVIRONMENT -GUIDANCE
Conducted RF IEC 61000-4-6	3 Vrms 150 kHz to 80 MHz	3 Vrms	<p>Portable and mobile RF communications equipment should be used no closer to any part of the device, including cables, than the recommended separation distance calculated from the equation applicable to the frequency of the transmitter.</p> <p>Recommended separation distance $d = 1.2 \sqrt{P}$</p> <p>$d = 1.2 \sqrt{P}$ 80 MHz to 800 MHz $d = 2.3 \sqrt{P}$ 800 MHz to 2.5 GHz</p> <p>where P is the maximum output power rating of the transmitter in watts (W) according to the transmitter manufacturer and d is the recommended separation distance in meters (m).</p> <p>Field strengths from fixed RF transmitters, as determined by an electromagnetic site survey^a, should be less than the compliance level in each frequency range.^b</p> <p>Interference may occur in the vicinity of equipment marked with the following symbol: </p>
Radiated RF IEC 61000-4-3	3 V/m 80 MHz to 2.5 GHz	3 V/m	
<p>NOTE 1 At 80 MHz and 800 MHz, the higher frequency range applies.</p> <p>NOTE 2 These guidelines may not apply in all situations. Electromagnetic propagation is affected by absorption and reflection from structures, objects, and people.</p> <p>a Field strengths from fixed transmitters, such as base stations for radio (cellular/cordless) telephones and land mobile radios, amateur radio, AM and FM radio broadcast and TV broadcast cannot be predicted theoretically with accuracy. To assess the electromagnetic environment due to fixed RF transmitters, an electromagnetic site survey should be considered. If the measured field strength in the location in which the device is used exceeds the applicable RF compliance level above, the device should be observed to verify normal operation. If abnormal performance is observed, additional measures may be necessary, such as re-orienting or relocating the device.</p> <p>b Over the frequency range 150 kHz to 80 MHz, the field strengths should be less than 3 V/m.</p>			

Recommended Separation Distances between Portable and Mobile RF Communications Equipment and This Device: The device is intended for use in an electromagnetic environment in which radiated RF disturbances are controlled. The customer or the user of this device can help prevent electromagnetic interference by maintaining a minimum distance between portable and mobile RF communications equipment (transmitters) and this device as recommended below, according to the maximum output power of the communications equipment.

RATED MAXIMUM POWER OUTPUT OF TRANSMITTER W	SEPARATION DISTANCE ACCORDING TO FREQUENCY OF TRANSMITTER M		
	150 kHz TO 80 MHz $d = 1.2 \sqrt{P}$	80 MHz TO 800 MHz $d = 1.2 \sqrt{P}$	800 MHz TO 2.5 GHz $d = 2.3 \sqrt{P}$
0.01	0.12	0.12	0.23
0.1	0.38	0.38	0.73
1	1.2	1.2	2.3
10	3.8	3.8	7.3
100	12	12	23
<p>For transmitters rated at a maximum output power not listed above, the recommended separation distance d in meters (m) can be estimated using the equation applicable to the frequency of the transmitter, where P is the maximum output power rating of the transmitter in watts (W) according to the transmitter manufacturer.</p> <p>Note 1: At 80 MHz and 800 MHz, the separation distance for the higher frequency range applies.</p> <p>Note 2: These guidelines may not apply in all situations. Electromagnetic propagation is affected by absorption and reflection from structures, objects, and people.</p>			



Respironics Inc.
1001 Murry Ridge Lane
Murrysville, PA 15668 USA



REF 1095731

1095497 R00
JR 12/01/2011
EN-DOM