



**ResMed**

 **Respshop**  
better sleep, better life.  
**Click Here To Buy**

**AirFit™** N20

Nasal mask



User guide  
English

Fitting / Mise en place / Colocación / Colocação **R<sub>x</sub>** Only

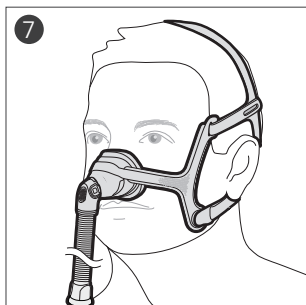
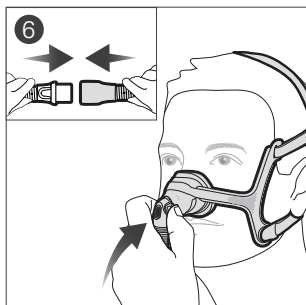
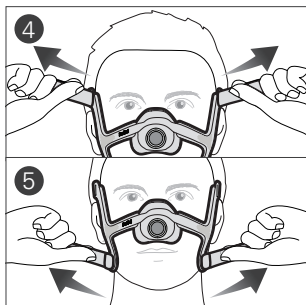
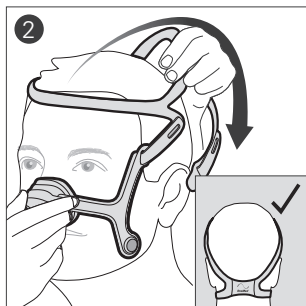
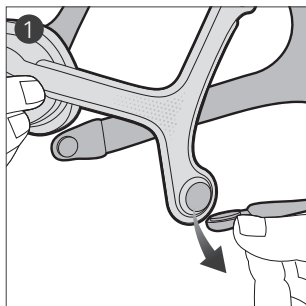

## Adjustment / Ajustement / Ajuste / Ajuste

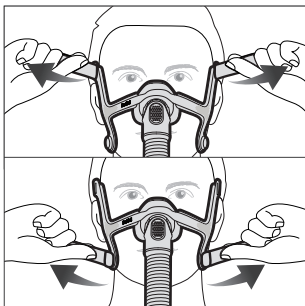
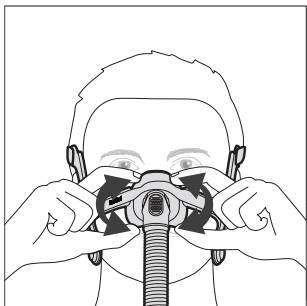

## Removal / Retrait / Remoción / Remoção

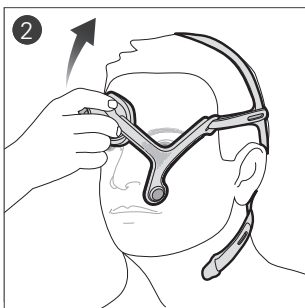
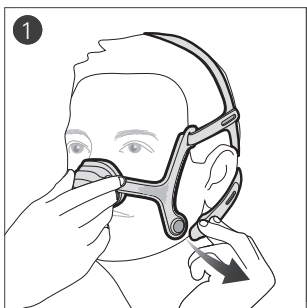

Disassembly / Démontage / Desensablado /  
Desmontagem

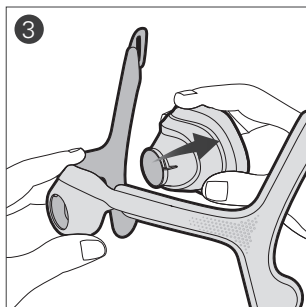
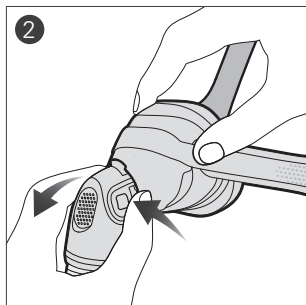
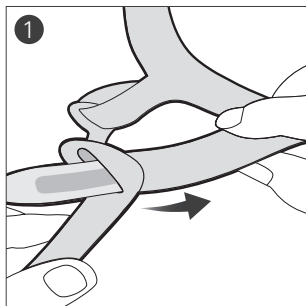

# Reassembly / Remontage / Reensamblado / Remontagem

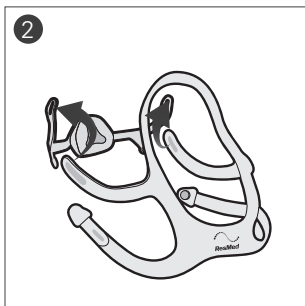
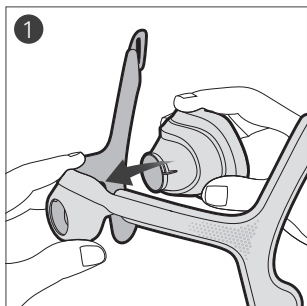

Cleaning your mask at home / Nettoyage de votre masque à domicile / Limpieza de la mascarilla en el domicilio / Limpeza da máscara em casa

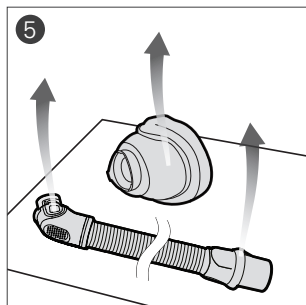
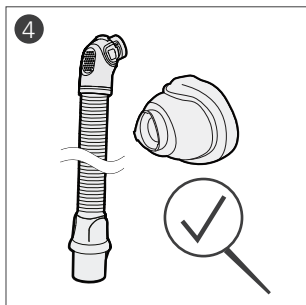
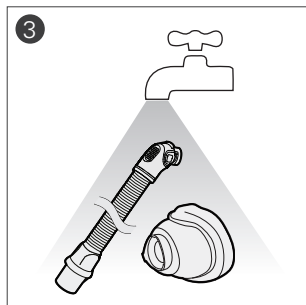
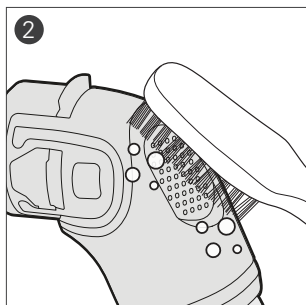
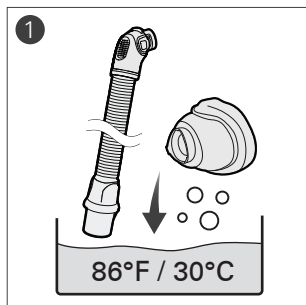

# AirFit™ N20

## Nasal Mask

Thank you for choosing the AirFit N20. This document provides the user instructions for the AirFit N20 and AirFit N20 for Her masks referred to collectively as AirFit N20 throughout this manual.

## Using this guide

Please read the entire guide before use. When following instructions, refer to the images at the front of the guide.

## Intended use

The AirFit N20 channels airflow non-invasively to a patient from a positive airway pressure (PAP) device such as a continuous positive airway pressure (CPAP) or bilevel device.

The AirFit N20 is:

- to be used by patients weighing more than 66 lb (30 kg) for whom positive airway pressure has been prescribed
- intended for single-patient re-use in the home environment and multi-patient re-use in the hospital/institutional environment.

## WARNING

Magnets are used in the lower headgear straps and the frame of the AirFit N20. Ensure the headgear and frame is kept at least 2" (50 mm) away from any active medical implant (eg, pacemaker or defibrillator) to avoid possible effects from localized magnetic fields. The magnetic field strength is less than 400 mT.

## Contraindications

Use of masks with magnetic components is contraindicated in patients with the following pre-existing conditions:

- a metallic hemostatic clip implanted in your head to repair an aneurysm
- metallic splinters in one or both eyes following a penetrating eye injury.

## GENERAL WARNINGS

- The vent holes must be kept clear.
- The mask should only be used with CPAP or bilevel devices recommended by a physician or respiratory therapist.
- The mask should not be used unless the device is turned on. Once the mask is fitted, ensure the device is blowing air. Explanation: CPAP and bilevel devices are intended to be used with special masks (or connectors) which have vent holes to allow continuous flow of air out of the mask. When the device is turned on and functioning properly, new air from the device flushes the exhaled air out through the mask vent holes. However, when the device is not operating, insufficient fresh air will be provided through the mask, and the exhaled air may be rebreathed. Rebreathing of exhaled air for longer than several minutes can, in some circumstances, lead to suffocation. This applies to most models of CPAP or bilevel devices.
- Follow all precautions when using supplemental oxygen.
- Oxygen flow must be turned off when the CPAP or bilevel device is not operating, so that unused oxygen does not accumulate within the device enclosure and create a risk of fire.
- Oxygen supports combustion. Oxygen must not be used while smoking or in the presence of an open flame. Only use oxygen in well ventilated rooms.
- At a fixed rate of supplemental oxygen flow, the inhaled oxygen concentration varies, depending on the pressure settings, patient breathing pattern, mask, point of application and leak rate. This warning applies to most types of CPAP or bilevel devices.
- The technical specifications of the mask are provided for your clinician to check that they are compatible with the CPAP or bilevel device. If used outside specification or if used with incompatible devices, the seal and comfort of the mask may not be effective, optimum therapy may not be achieved, and leak, or variation in the rate of leak, may affect the CPAP or bilevel device function.
- Discontinue using this mask if you have ANY adverse reaction to the use of the mask, and consult your physician or sleep therapist.
- Using a mask may cause tooth, gum or jaw soreness or aggravate an existing dental condition. If symptoms occur, consult your physician or dentist.



- As with all masks, some rebreathing may occur at low CPAP pressures.
- Refer to your CPAP or bilevel device manual for details on settings and operational information.
- Remove all packaging before using the mask.
- The mask must be used under qualified supervision for users who are unable to remove the mask by themselves.
- This mask is not for use on patients with impaired laryngeal reflexes or other conditions predisposing to aspiration in the event of regurgitation or vomiting.
- Avoid connecting flexible PVC products (eg, PVC tubing) directly to any part of the mask. Flexible PVC contains elements that can be damaging to the materials of the mask, and may cause the components to crack or break.<sup>3</sup>
- N20 line of nasal CPAP masks are not intended to be used simultaneously with nebulizer medications that are in the air path of the mask/tube.
- The mask contains an exhaust port safety feature to enable normal breathing. The mask should not be worn if this safety feature is damaged or missing.

## Using your mask

When using your mask with ResMed CPAP or bilevel devices that have mask setting options, refer to the Technical specifications section in this user guide for the correct setting.

For a full list of compatible devices for this mask, see the Mask/Device Compatibility List on [www.resmed.com/downloads/masks](http://www.resmed.com/downloads/masks). If you do not have internet access, please contact your ResMed representative.

## Fitting

1. Twist and pull both magnetic clips away from the frame.
2. With both lower headgear straps released, hold the mask against your face and pull the headgear over your head.

### **Headgear check:**

Ensure that the ResMed logo on the headgear is facing outwards and is upright when the headgear is put on.

3. Bring the lower straps below your ears, and attach the magnetic clip to the frame.

4. Undo the fastening tabs on the upper headgear straps. Adjust the straps evenly until the mask sits comfortably just over the nose. Reattach the fastening tabs.
5. Undo the fastening tabs on the lower headgear straps. Adjust the straps evenly until the mask is stable. Reattach the fastening tabs.
6. Connect the device air tubing to the short tube. Attach the elbow to the mask by pressing the side buttons and pushing the elbow into the mask, ensuring it clicks in on both sides.
7. Your mask and headgear should be positioned as shown in the illustration.

## Adjustment

If necessary, slightly adjust the position of the mask for the most comfortable fit. Ensure that the cushion is not creased and the headgear is not twisted.

1. Turn on your device so that it is blowing air.

### **Adjustment tips:**

- ✓ To resolve any leaks at the upper part of the mask, adjust the upper headgear straps. For the lower part, adjust the lower headgear straps. Adjust only enough for a comfortable seal.
- ✓ The upper strap adjustment is the key to seal and comfort.
- ✓ Do not overtighten the lower straps because they mainly serve to keep the cushion in position.

## Removal

1. Twist and pull both magnetic clips away from the frame.
2. Pull the mask away from your face and back over your head.

## Disassembly

If the mask is connected to your device, disconnect the device air tubing from the short tube.

1. Undo the fastening tabs on the upper headgear straps. Pull the straps out of the frame.

**Tip:** Keep the magnetic clips attached to the lower headgear straps to easily distinguish the upper and lower straps when reassembling.

2. Remove the elbow from the mask by pressing the side button and pulling the elbow away.
3. Hold the frame by placing your thumb over the side slot. Pull the cushion away from the frame.

## Reassembly

1. Push the cushion into the frame. The frame has a shape that allows you to insert the cushion only one way.
2. With the ResMed logo on the headgear facing outside and upright, thread the upper headgear straps into the frame slots from the inside. Fold them over to secure.

## Cleaning your mask at home

It is important to follow the steps below to get the best performance out of your mask.

### WARNING

- As part of good hygiene, always follow cleaning instructions and use a mild liquid detergent. Some cleaning products may damage the mask, its parts and their function, or leave harmful residual vapours that could be inhaled if not rinsed thoroughly.
- Regularly clean your mask and its components to maintain the quality of your mask and to prevent the growth of germs that can adversely affect your health.

### CAUTION

If any visible deterioration of a system component is apparent (cracking, crazing, tears etc), the component should be discarded and replaced.

### **Daily/After each use:**

Before cleaning, take the mask components apart according to the disassembly instructions.

1. Soak and agitate the cushion, elbow and short tube in warm water (approximately 86°F/30°C) using a mild liquid detergent for up to 10 minutes.
2. Clean the components with a soft bristle brush, paying particular attention to the small vent holes on the elbow.
3. Thoroughly rinse the components under warm flowing drinking quality water.
4. Inspect each component to ensure that they are visually clean and free of detergent residue. If required, repeat washing.
5. Allow the components to dry out of direct sunlight before assembling.

### **Weekly:**

The magnetic clips can be left on for washing.

1. Soak and agitate the separated headgear and frame in warm water (approximately 86°F/30°C) using a mild liquid detergent for up to 10 minutes.
2. To rinse the components, repeatedly squeeze them under warm flowing drinking quality water until it is free of detergent residue.
3. Squeeze the components to remove excess water.
4. Allow the components to dry out of direct sunlight before assembling.

## **Reprocessing the mask between patients**

Reprocess this mask when using between patients. Cleaning, disinfection and sterilization instructions are available on [www.resmed.com/downloads/masks](http://www.resmed.com/downloads/masks). If you do not have internet access, please contact your ResMed representative.

## Troubleshooting

Problem/possible cause	Solution
<b>Mask is too noisy.</b>	
Vent is dirty.	Clean the vent according to the instructions.
Mask is incorrectly assembled.	Disassemble the mask, then reassemble according to the instructions.
Mask is leaking.	Refit or reposition your mask. Readjust the headgear straps to bring the mask closer to the face and improve your seal. Check that your mask is assembled correctly.
<b>Mask leaks around face.</b>	
Mask is not positioned correctly.	Check that the mask size indicator is facing downward on the bottom of the cushion along the bottom of your nose.
Mask may have been fitted incorrectly.	Pull the mask away from your face and reposition, ensuring that the lower corners of the mask fully enclose your nose. If necessary, readjust the headgear straps to keep the mask in the right place.
Cushion may be dirty.	Clean the cushion according to the instructions.
Cushion membrane is creased or folded.	Remove and refit your mask according to the fitting instructions. Ensure that you position the cushion correctly over your nose before pulling the headgear over your head. Do not slide the mask down your face during fitting as this may lead to folding or curling of the cushion.
Mask is not tightened correctly.	Ensure that the headgear straps are not overtightened or too loose. You may find that this mask does not need to be tightened as much as other nasal masks. Check that the headgear is not twisted.
Mask may be the wrong size.	Talk to your clinician.
<b>Mask does not fit properly.</b>	
Mask is incorrectly assembled.	Disassemble the mask, then reassemble according to the instructions.
Mask may be the wrong size.	Talk to your clinician.

## Technical specifications

**Pressure-flow curve** The mask contains passive venting to protect against rebreathing. As a result of manufacturing variations, the vent flow rate may vary.

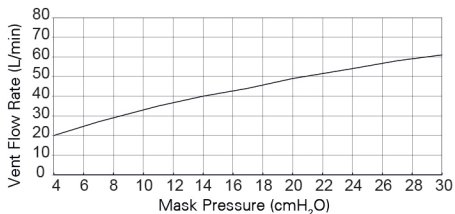

Pressure (cm H <sub>2</sub> O)	Flow (L/min)
4	20
7	27
11	35
14	40
17	44
20	49
24	54
27	58
30	61

**Dead space information** Physical dead space is the empty volume of the mask to the end of the swivel. Using the large cushions it is 103.3 mL.

**Therapy pressure** 4 to 30 cm H<sub>2</sub>O

**Resistance** Drop in pressure measured (nominal)  
at 50 L/min: 0.3 cm H<sub>2</sub>O  
at 100 L/min: 1.3 cm H<sub>2</sub>O

**Environmental conditions** Operating temperature: 41°F to +104°F (5°C to 40°C)  
Operating humidity: 15% to 95% non-condensing  
Storage and transport temperature: -4°F to +140°F (-20°C to +60°C)  
Storage and transport humidity: up to 95% non-condensing

**Sound** DECLARED DUAL-NUMBER NOISE EMISSION VALUES in accordance with ISO 4871. The A-weighted sound power level of the mask is 24 dBA, with uncertainty of 3 dBA. The A-weighted sound pressure level of the mask at a distance of 1 m is 16 dBA, with uncertainty of 3 dBA.

**Gross dimensions** 13.3" (H) x 11.4" (W) x 6.4" (D)  
(339 mm (H) x 291 mm (W) x 162 mm (D))  
Mask fully assembled with the short tube assembly and swivel, excluding the headgear

<b>International Commission on Non-Ionizing Radiation Protection (ICNIRP)</b>	Magnets used in this mask are within ICNIRP guidelines for general public use.
<b>Service life</b>	The service life of the AirFit N20 mask system is dependent on the intensity of usage, maintenance, and environmental conditions to which the mask is used or stored. As this mask system and its components are modular in nature, it is recommended that the user maintain and inspect it on a regular basis, and replace the mask system or any components if deemed necessary or according to the 'visual criteria for product inspection' in the 'Cleaning your mask at home' section of this guide. Refer to the 'Mask components' section of this guide for information of how to order replacement parts.
<b>Mask setting options</b>	For AirSense, AirCurve and S9: Select 'Pillows'. For other devices: Select 'SWIFT' (if available), otherwise select 'MIRAGE' as the mask option.
	<p>Device Setting Pillows</p>

### Notes:

- This product is not made with PVC, DEHP, DBP or BBP.
- This product is not made with natural rubber latex.
- The manufacturer reserves the right to change these specifications without notice.

## Storage

Ensure that the mask is thoroughly clean and dry before storing it for any length of time. Store the mask in a dry place out of direct sunlight.

## Disposal

This mask does not contain any hazardous substances and may be disposed of with your normal household refuse.

# Symbols

The following symbols may appear on your product or packaging:



Catalog number



Batch code



Humidity limitation



Temperature limitation



Manufacturer



European Authorized Representative



Keep away from rain



This way up



Nasal mask



Device setting - Pillows



Size - small



Size - medium



Size - large



Fragile, handle with care



Indicates a Warning or Caution and alerts you to a possible injury or explains special measures for the safe and effective use of the device



Caution, consult accompanying documents



Prescription only (In the US, Federal law restricts these devices to sale by or on the order of a physician)



## Limited warranty

ResMed Ltd (ResMed) warrants that your ResMed mask system (including mask frame, cushion, headgear and tubing) will be free from defects in material and workmanship from the date of purchase for 90 days, or in the case of disposable masks and disposable mask components for 7 days. This warranty is only available to the initial consumer. It is not transferable. If the product fails under conditions of normal use, ResMed will repair or replace, at its option, the defective product or any of its components. This limited warranty does not cover: a) any damage caused as a result of improper use, abuse, modification or alteration of the product; b) repairs carried out by any service organization that has not been expressly authorized by ResMed to perform such repairs; and c) any damage or contamination due to cigarette, pipe, cigar or other smoke. Warranty is void on product sold, or resold, outside the region of original purchase.

Warranty claims on defective product must be made by the initial consumer at the point of purchase.

This warranty replaces all other expressed or implied warranties, including any implied warranty of merchantability or fitness for a particular purpose. Some regions or states do not allow limitations on how long an implied warranty lasts, so the above limitation may not apply to you.

ResMed will not be responsible for any incidental or consequential damages claimed to have resulted from the sale, installation or use of any ResMed product. Some regions or states do not allow the exclusion or limitation of incidental or consequential damages, so the above limitation may not apply to you. This warranty gives you specific legal rights, and you may also have other rights which vary from region to region. For further information on your warranty rights, contact your local ResMed dealer or ResMed office.

Mask components / Composants du masque /  
Piezas de la mascarilla / Componentes da máscara

		AirFit N20	AirFit N20 for Her
<b>A</b>	<b>Elbow and short tube / Coude et tuyau court / Codo y tubo corto / Cotovelo e tubo curto</b>	63565	63565
1	Elbow / Coude / Codo / Cotovelo		
2	Side buttons / Boutons latéraux / Botones laterales / Botões laterais		
3	Vent / Orifice de ventilation / Ventilación / Respiradouro		
4	Short tube / Tuyau court / Tubo corto / Tubo curto		
5	Swivel / Pièce pivotante / Pieza giratoria / Peça giratória		
<b>B</b>	<b>Frame / Entourage rigide / Armazón / Armação</b>	—	—
<b>C</b>	<b>Cushion / Bulle / Almohadilla / Almofada</b>	63550 (S) 63551 (M) 63552 (L)	63550 (S) 63551 (M) 63552 (L)
<b>D</b>	<b>Headgear / Harnais / Arnés / Arnês</b>	63560 (S) 63561 (Std) 63562 (L)	63558
6	Magnetic clips (2 pack) / Clips magnétiques (paquet de 2) / Broches magnéticos (paquete de 2 unidades) / Presilhas magnéticas (2 unidades)	63564	63564

		AirFit N20	AirFit N20 for Her
7	Lower headgear straps / Sangles inférieures du harnais / Correas inferiores del arnés / Correias inferiores do arnês		
8	Upper headgear straps / Sangles supérieures du harnais / Correas superiores del arnés / Correias superiores do arnês		
<b>A+B+C</b>			
	<b>Frame system / Entourage complet / Sistema de armazón / Sistema de armação</b>	63553 (S) 63555 (M) 63556 (L)	63554 (S)
<b>A+B+C+D</b>			
	<b>Complete system / Masque complet / Sistema completo / Sistema completo</b>	63503 (S) 63501 (M) 63502 (L)	63500 (S)

S: Small / Small / Pequeña / Pequeno

M: Medium / Medium / Mediana / Médio

L: Large / Large / Grande / Grande

Std: Standard / Standard / Estándar / Padrão



**ResMed**

**AirFit™** N20

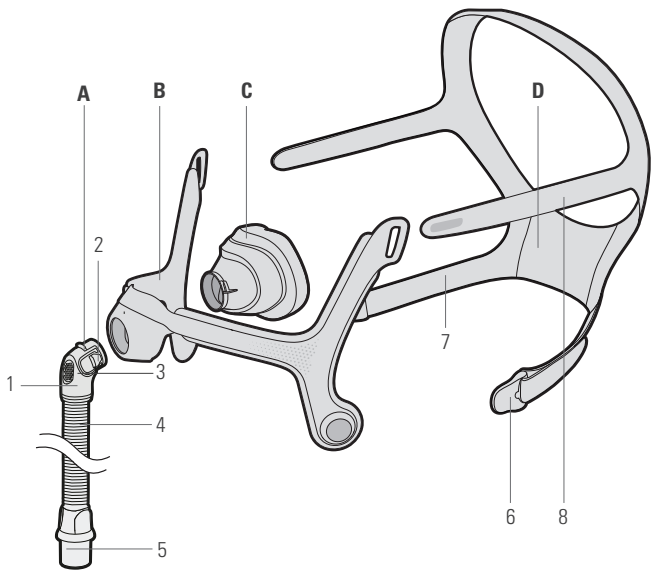

**ResMed Ltd**

1 Elizabeth Macarthur  
Drive Bella Vista NSW  
2153 Australia

**Distributed by**

ResMed Corp 9001 Spectrum Center Boulevard San Diego CA 92123 USA  
**EC REP** ResMed (UK) Ltd 96 Jubilee Ave Milton Park Abingdon  
Oxfordshire OX14 4RW UK

See ResMed.com for other ResMed locations worldwide. AirFit, AirSense and AirCurve are trademarks of the ResMed family of companies. For patent and other intellectual property information, see ResMed.com/ip.

© 2016 ResMed Ltd. 638088/1 2016-10

ResMed.com



638088