

EasyFit[®] SilkGel Nasal Mask

Instructions for Use

Caution:

Federal Law (U.S.A.) restricts this device to sale by or on the order of a physician

Latex Free

Table of Contents

1	Introduction	4
1.1	Intended use	5
1.2	Contraindications	5
1.3	Side effects	5
1.4	Duty to provide instruction	6
2	Safety	6
2.1	Warnings in this document	6
2.2	Safety information	7
2.3	General information	9
3	Product description	10
3.1	Overview	10
3.2	Compatible devices	12
3.3	Exhalation system	13
3.4	Ports for pressure measurement	14
4	Operation	15
4.1	Apply mask	15
4.2	Remove mask	16
4.3	Adjust mask	17
4.4	Disassemble mask	19
4.5	Assemble mask	23

5	Cleaning instructions	28
5.1	Clean mask	28
5.2	Tips	30
5.3	Change of patient	30
6	Disposal	30
7	Troubleshooting	31
8	Item List	32
8.1	Complete System	32
8.2	Replacement Cushions	32
8.3	Replacement Headgear	32
8.4	Parts and Accessories	33
8.5	Instructions	33
9	Technical data	34
9.1	Specifications	34
9.2	Materials	35
9.3	Characteristic pressure/flow curve	36

1 Introduction

These instructions for use ensure that the mask is used safely and effectively. These instructions must be stored in an easily accessible place at all times. They must be read and understood prior to use.

Liability limitations

All information and instructions in these instructions for use have been compiled based on the current valid standards and regulations, the latest state-of-the-art technology and our longstanding experience and knowledge in the field. DeVilbiss accepts no liability in the following circumstances:

- Failure to comply with these instructions for use
- Use other than the intended use
- Independently implemented alterations
- Technical alterations

1.1 Intended use

The Nasal Mask is intended for prescription use to be used during nasal CPAP or Bi-Level Positive Pressure therapy for adult patients (>30kg).

1.2 Contraindications

Use of this device may be contraindicated under the following conditions: Erosions and ulcerations, skin allergies, skin rashes on the face, pressure points on the face, claustrophobia, anxiety, deformities of the face or nasopharynx, ingestion of drugs which may induce vomiting, the necessity for immediate intubation. You should also observe the contraindications in the instructions for use for your therapy device.

If you experience any of these symptoms, consult your doctor.

1.3 Side effects

The following side effects may occur during short-term or long-term use: Blocked nose, dry nose, dry mouth in the morning, feeling of pressure in the sinuses, irritated mucous membrane, skin rashes, pressure points in the face, irritating noises when breathing.

If you experience any of these symptoms, consult your doctor.

1.4 Duty to provide instruction

Ensure that your doctor or home healthcare medical equipment provider instructs you in the use of the mask before beginning therapy.

2 Safety

Read these instructions for use carefully. They are an essential part of the mask and must be available at all times.

2.1 Warnings in this document

Warnings indicate information relevant to safety.

Within instructions, you will find warnings in front of a step which contains a hazard to persons or objects.

Safety instructions consist of:

- The warning symbol (pictogram)
- A word to indicate the level of a hazard
- Information about the hazard and
- Instructions on how to avoid the hazard.

There are three levels of warning instruction, depending on the degree of hazard.



DANGER

Indicates an unusually great hazard. If you do not follow this instruction, severe irreversible injuries or death will result.

 **WARNING**

Indicates an unusually great hazard. If you do not follow this instruction, severe irreversible or fatal injuries may result.

 **CAUTION**

Indicates a hazard. If you do not follow this instruction, mild or moderate injuries may result.

NOTICE

Indicates material hazards. If you do not follow this instruction, material damage may result.

 **i**

Indicates useful tips within procedures.

2.2 Safety information

2.2.1 Warnings

Risk of injury from the supply of oxygen!

Oxygen can become deposited in clothing, bed linen and hair. In conjunction with smoking, open flame and electrical equipment, it can cause fires and explosions.

- ⇒ Do not smoke.
- ⇒ Avoid open flame.
- ⇒ Do not use electrically-conductive tubes (exception: heated breathing tubes).

Risk of injury from re-inhaling CO₂!

If the mask is used incorrectly, CO₂ may be re-inhaled. The flow of air from the therapy device serves, among other things, to remove the exhaled air from the mask and tube. If the therapy device is not switched on, there is a risk of re-inhalation. In some circumstances, this may lead to suffocation.

- ⇒ Do not seal the openings of the mask.
- ⇒ Only put mask on for a prolonged period if the therapy device is running.
- ⇒ Use the mask only within the quoted therapy pressure range.
- ⇒ Do not use mask on patients who cannot take off the mask independently or who tend to vomit.

- This CPAP mask should be used only with CPAP systems recommended by your physician or respiratory therapist.
- If oxygen is used with the CPAP system, the oxygen flow must be turned off when the CPAP machine is not operating.

Explanation of the warning:

When the CPAP device is not in operation and the oxygen flow is left on, oxygen delivered into the ventilator tubing may accumulate within the CPAP machine enclosure. Oxygen accumulated in the CPAP machine enclosure will create a risk of fire. This warning applies to most types of CPAP systems.

2.2.2 Cautions

Risk of injury from oxygen therapy!

Oxygen therapies can lead to side effects if incorrectly used/ metered.

- ⇒ Only administer oxygen following prescription by a physician.
- ⇒ Follow the instructions for use of the oxygen system and the therapy device.

Risk of injury from mask slipping!

If the mask slips or falls off, therapy is ineffective.

- ⇒ Monitor patients with restricted ability to breathe spontaneously.
- ⇒ Activate low pressure/leakage alarms on therapy device.
- ⇒ Subject patients with obstructive and restrictive lung diseases to individual monitoring.

2.3 General information

- If third-party items are used, functional failures and restricted fitness for use may result. Biocompatibility requirements may also not be met. Please note that in these cases, any claim under warranty and liability will be void if neither the accessories nor genuine replacement parts recommended in the instructions for use are used.
- The mask parts filled with gel are sensitive components. Handle them with care to prevent deformations and damage.

- To prevent an infection, bacterial contamination or functional impairments, follow the instructions in the section entitled "Cleaning instructions" (see 5, p. 28). Inappropriate cleaning procedures, unsuitable cleaning agents and infrequent cleaning can result in an infection or bacterial contamination and can impede the functioning of the mask.

3 Product description

3.1 Overview

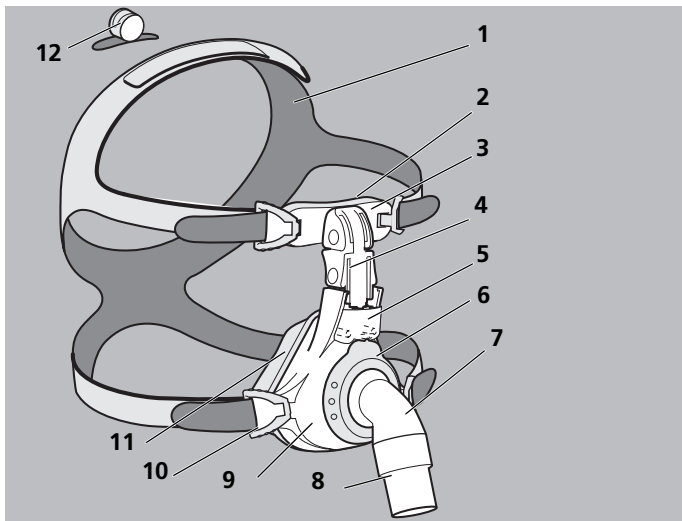

No.	Designation	Description
1	Headgear for EasyFit® SilkGel	The headgear is used to secure the mask on the head.
2	Forehead cushion	The forehead cushion acts as a pillow between the forehead support and the head. It ensures that the forehead support lies softly against the head and that little pressure is applied.
3	Fine adjustment component	Fine adjustment component enables you to modify the distance between the forehead cushion and the forehead.
4	Coarse adjustment component	Coarse adjustment component enables you to modify the distance between the cushion and the forehead.
5	Ports for pressure measurement with port cap	A pressure measurement tube or oxygen supply can be connected. Close the ports if they are not being used.
6	Retaining ring	The retaining ring keeps the elbow in position.
7	Elbow	The elbow with ball joint can be rotated up to 360°.
8	Rotating sleeve	The rotating sleeve connects the mask tube to the elbow so that it can be rotated. The mask tube can be disconnected from the elbow at the rotating sleeve for cleaning.
9	Mask frame	Basic frame of the mask.
10	Headgear clips	The headgear clips connect the mask to the headgear.

No.	Designation	Description
11	Mask cushion	The mask cushion acts as a pillow between the mask frame and the face. It ensures that the mask frame lies softly against the face and that little pressure is applied.
12	Tube anchoring strap	The tube anchoring strap is used to fix the device tube to the side or the top of the headgear if you want to keep the device tube in over-head position while sleeping.

3.2 Compatible devices

- You can use the mask with all therapy devices which are for the non-life-support treatment of patients with sleep apnea or respiratory insufficiency.
- With many combinations of device, the actual pressure in the mask will not correspond to the prescribed therapy pressure, even if the therapy device is displaying the correct pressure. Have the device combination adjusted by a physician or provider so that the actual pressure in the mask corresponds to therapy pressure.
- If your ventilation device has leakage or low pressure alarms, set these so that an alarm is triggered as soon as you remove the mask or it slips out of position.

3.3 Exhalation system

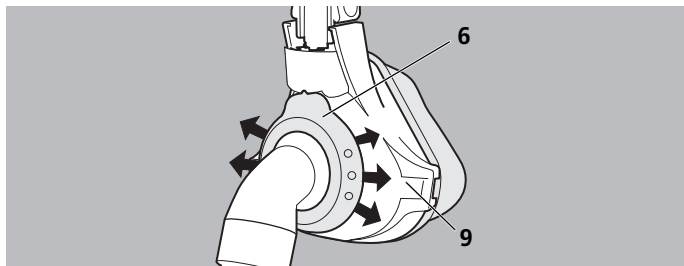

The mask has an integrated exhalation system. The retaining ring **6** and mask frame **9** are shaped so that a gap forms between these parts. The exhaled air can escape through this gap. The specific geometry of the parts ensures that the rotating sleeve cannot seal this gap when it is pushed into place. Never close the gap. This will ensure that no CO₂ builds up in the mask.

3.4 Ports for pressure measurement

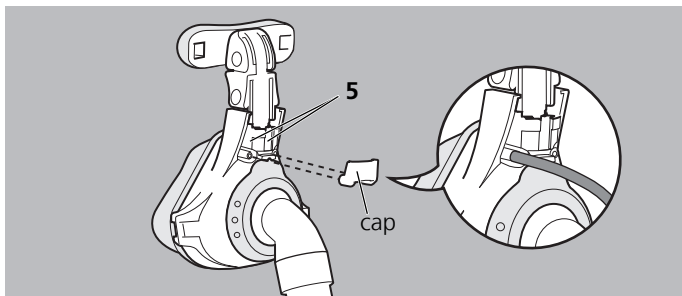

The mask has two ports **5** which you can use for measuring pressure or for supplying oxygen. If you are not using the ports, seal them using the cap in order to achieve therapy pressure.

4 Operation

4.1 Apply mask

1. Unfasten the bottom headgear clip on the mask.

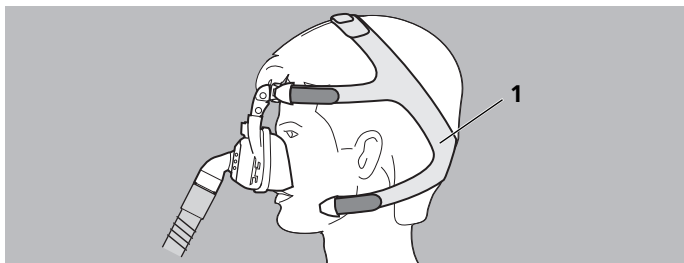

2. Pull headgear **1** over your head and place the mask on the face.

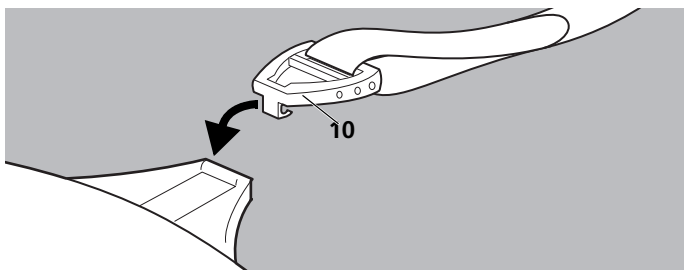

3. Attach headgear clip **10** to the mask.

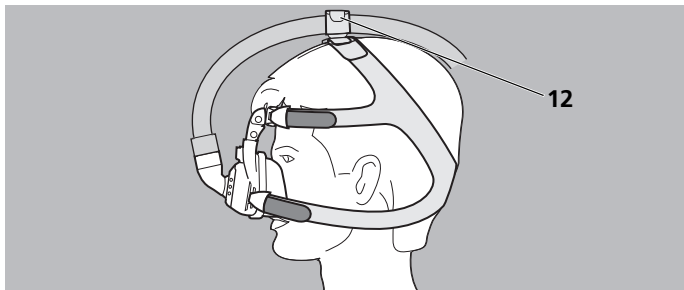

4. If the breathing tube is to be routed over the head: attach the tube to the headgear using tube anchoring strap **12**.

4.2 Remove mask

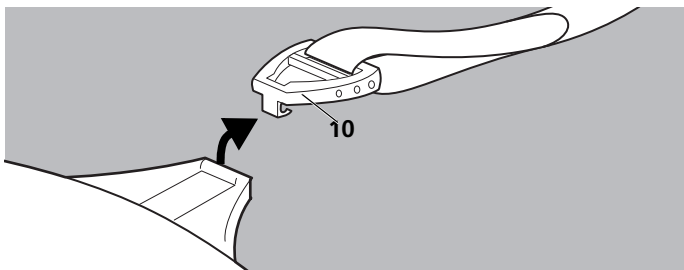

1. Unfasten the bottom headgear clip **10** on the mask.
2. Disconnect mask tube from the ventilation tube of the therapy device.
3. Remove mask from your head.

4.3 Adjust mask

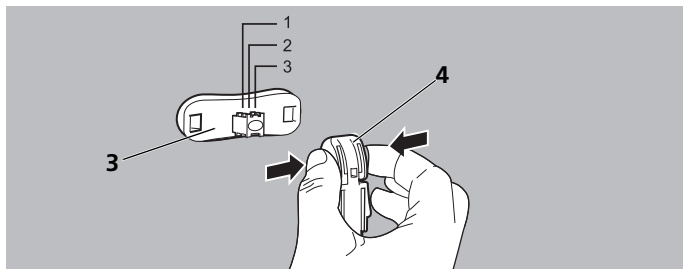

1. Keep the top tabs of coarse adjustment component **4** depressed.
2. Push fine adjustment component **3** into one of the three engaged positions.
3. If you need to adapt the height of forehead cushion **1**: rotate fine adjustment component **3** through 180°.

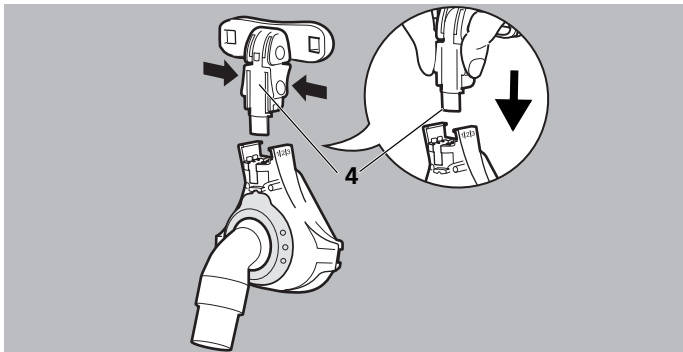

4. Keep the bottom tabs of coarse adjustment component **4** depressed.
5. Push coarse adjustment component **4** into one of the three engaged positions (marked 1, 2 and 3) of the mask frame.
6. Apply mask (see "4.1 Apply mask" page 15).

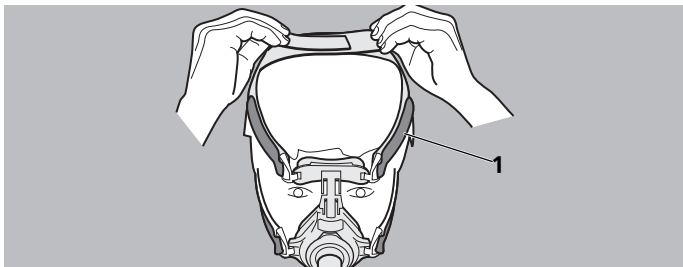

7. Adjust headgear **1** with the aid of the hook-and-loop tabs so that the mask seals on the face but is not too tight.

i

The hook-and-loop tab on top of the head is easiest to adjust by loosening the tab, gently pulling on the ends of the headgear with both hands and pushing the tab back down firmly.

4.4 Disassemble mask

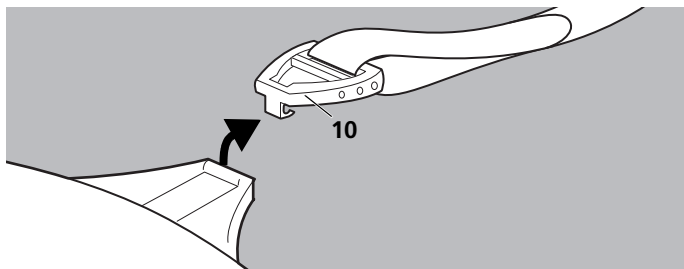

1. Unfasten the headgear clip **10** to remove headgear **1**.

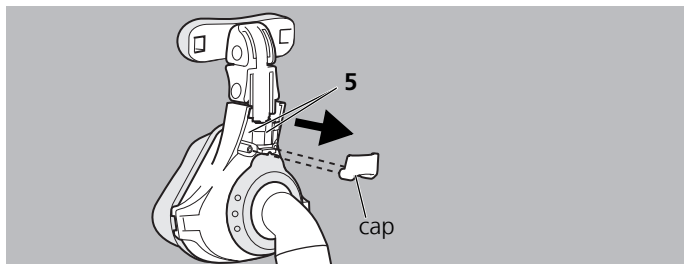

2. If necessary, remove the cap for pressure measurement ports **5**.

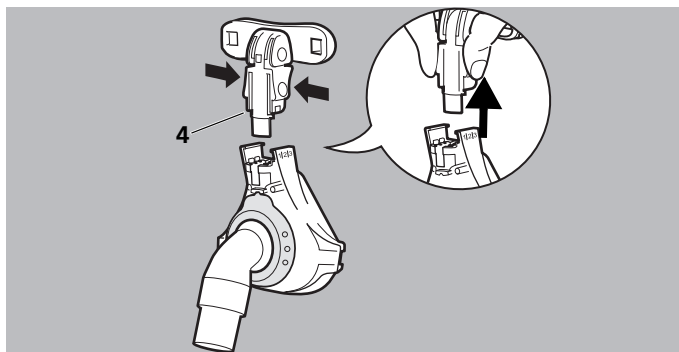

3. Keep the bottom tabs of coarse adjustment component **4** depressed and remove it.

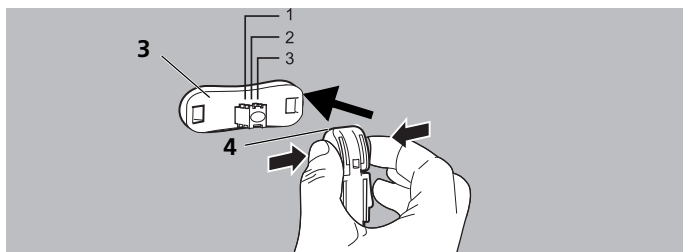

4. Keep the top tabs of coarse adjustment component **4** depressed and remove fine adjustment component **3**.

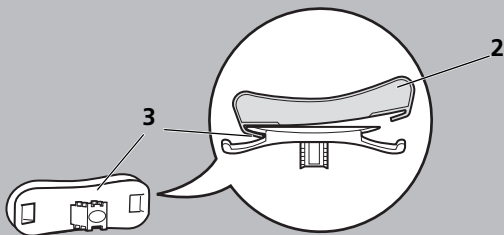

5. Remove forehead cushion **2** from fine adjustment component **3**

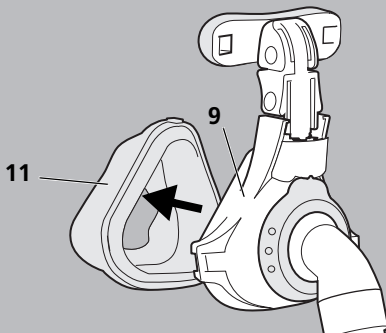

6. Take mask cushion **11** off mask frame **9**.

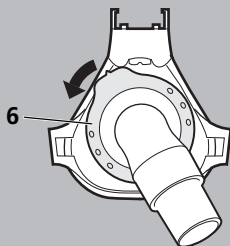

7. Turn retaining ring **6** counterclockwise and remove it.

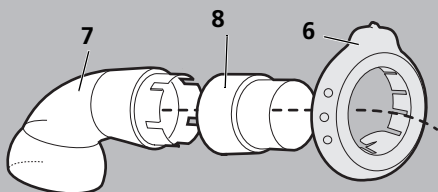

8. Take off elbow **7** through retaining ring **6**.
9. Take rotating sleeve **8** off elbow **7**.

4.5 Assemble mask

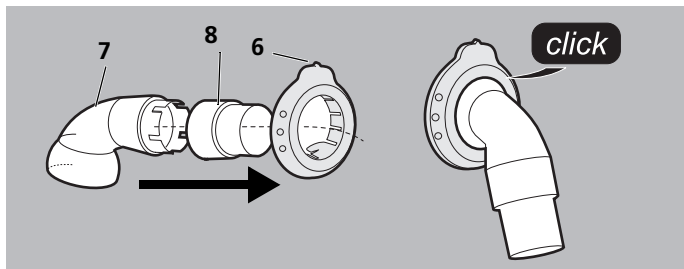

1. Press the rotating sleeve **8** onto elbow **7**.
2. Press elbow **7** into the retaining ring **6** until you hear it click into place.
3. Push retaining ring **6** and elbow **7** onto the mask frame.

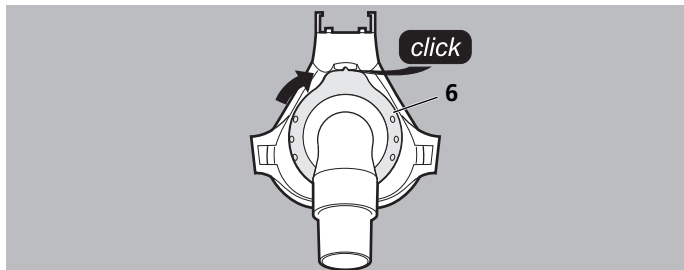

4. Turn retaining ring **6** clockwise to hear it click into place.

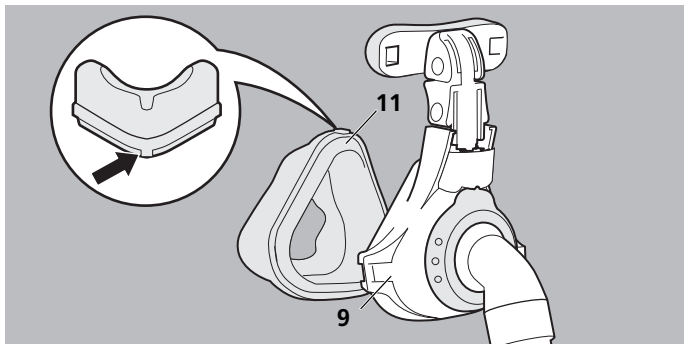

5. Attach mask cushion **11** to mask frame **9**. The centering aid helps you position the mask frame correctly.

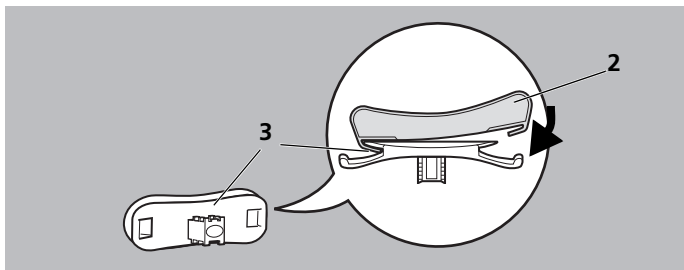

6. Hook in the forehead cushion **2** on one side of the fine adjustment component **3** and pull over the other side.

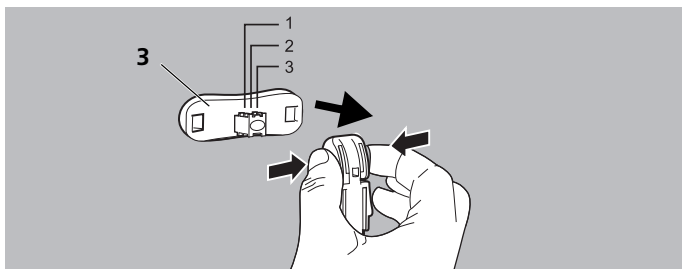

7. Push fine adjustment component **3** into one of the three engaged positions.

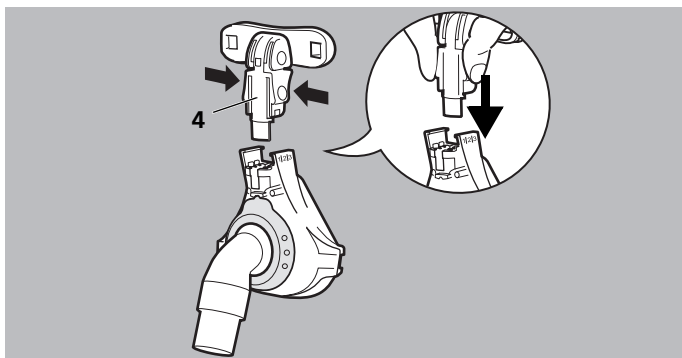

8. Keep the bottom tabs of coarse adjustment component **4** depressed and push coarse adjustment component **4** into one of the three engaged positions (marked 1, 2 and 3) of the mask frame.

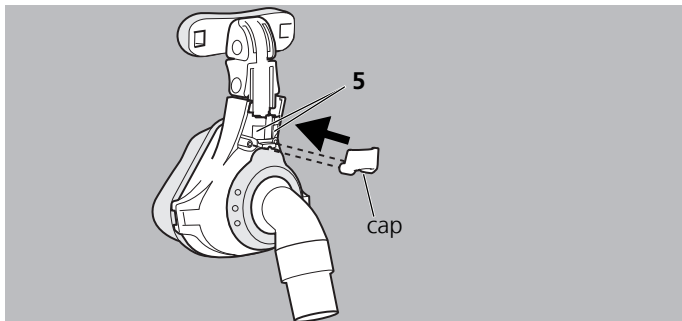

9. If necessary, push the cap onto the pressure measurement ports **5**.

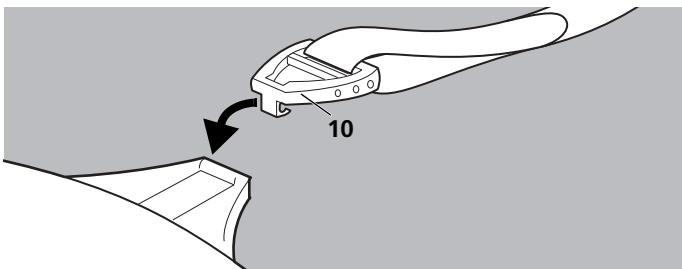

10. Attach headgear clips **10** to the mask.

i

You can tell whether the headgear is correctly attached by the hook-and-loop tabs. The hook-and-loop tabs on the forehead are light blue, those on the cheek are dark blue.

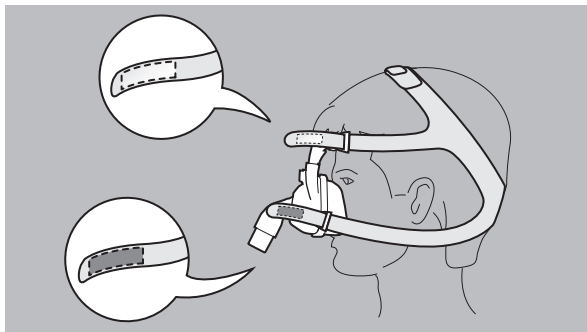

5 Cleaning instructions

⚠ WARNING**Risk of injury if cleaning is inadequate!**

Residues may block the mask, impair the integrated exhalation system and jeopardize the success of therapy.

- ⇒ For patients with a compromised immune system or particular background of illness, disinfect mask parts daily following consultation with the physician.
- ⇒ Thoroughly clean the contact surfaces between the elbow and the rotating sleeve.

NOTICE**Material damage from abrasion!**

Rubbing the mask cushion and forehead cushion can damage the coating.

- ⇒ Only clean mask cushion and forehead cushion when wet.
- ⇒ Do not rub mask cushion or forehead cushion when dry.

5.1 Clean mask

1. Disassemble mask (see "4.4 Disassemble mask" page 19).
2. Clean mask in accordance with the table below.

Part	Daily	Weekly
Wash mask parts with warm water using Palmolive® Ultra Original dishwashing liquid soap or a comparable mild detergent.	X	
When washing mask parts (except for mask cushion and forehead cushion), clean thoroughly with a cloth or a soft brush.		X
Wash headgear by hand.		X

- Carefully rinse all parts with clean water.

NOTICE

Material damage due to heat!

Direct sunlight or heat can damage parts of the mask.

- ⇒ Do not dry parts in direct sunlight.
- ⇒ Do not dry the headgear in a dryer.
- ⇒ Do not iron the headgear, otherwise the hook-and-loop tabs will stop gripping.

- Allow all parts to air-dry.
- Check all parts for residues. Repeat cleaning procedure if residues are still present.
- Perform a visual inspection.
- If necessary, replace damaged parts.
- Reassemble mask (see "4.5 Assemble mask" page 23).



Discolored mask parts do not impair the function of the mask.

5.2 Tips

- You can wash all parts (except headgear) in a dishwasher at 149 °F (65 °C).
- Wash headgear before first use, as the color may run.
- Handle the coating on the mask cushion and forehead cushion with care.
- Wear suitable gloves (e. g. disposable gloves) during the cleaning procedure.

5.3 Change of patient

This mask system is approved for multiple-patient use in a hospital or clinic environment such as sleep laboratories provided that appropriate hygienic measures are taken. Please contact your provider to obtain detailed cleaning and disinfecting instructions for multiple-patient use (order no. DV 67486).

6 Disposal

You can dispose of all parts in domestic waste.

7 Troubleshooting

Problem	Cause	Remedy
Pain in face due to pressure.	Mask is too tight.	Loosen headgear slightly. Modify position of forehead support.
Dry eyes.	Mask is too loose.	Tighten headgear slightly. Modify position of forehead support.
	Mask does not fit.	Use a different mask size. Contact your equipment provider.
Therapy pressure is not reached.	Mask not adjusted correctly.	Readjust mask (see "4.3 Adjust mask" page 17).
	Mask cushion damaged.	Replace mask cushion.
	Tube system leaking.	Check push-fit connector and fit of tube sleeves.
	Air escaping at pressure measurement ports.	Seal pressure measurement ports with cap (included).

8 Item List

8.1 Complete System

All masks are supplied fully assembled. Headgear and instructions for use DV67485 are included.

Size	Article no.
S	DV97318
M	DV97328
L	DV97338

8.2 Replacement Cushions

Article	Article no.
Mask cushion Size S	DV97352
Mask cushion Size M	DV97353
Mask cushion Size L	DV97354
Forehead cushion	DV97270

8.3 Replacement Headgear

Article	Article no.
Headgear EasyFit [®] SilkGel	DV97350
Headgear clips (4 pieces)	DV97218

8.4 Parts and Accessories

Article	Article no.
Ball-and-socket joint set (consisting of retaining ring, elbow and rotating sleeve)	DV15858
Rotating sleeve	DV97288
Cap for pressure measurement ports	DV97308
Forehead support (including coarse adjustment component and fine adjustment component)	DV15856
Tube anchoring strap	DV97213
Carrying bag	DV14623

8.5 Instructions

Article	Article no.
Instructions for use	DV67485
Cleaning and disinfecting instructions for multiple-patient use	DV67486

9 Technical data

9.1 Specifications

Dimensions (W x H x D)	c. 3.15" x 5.11" x 3.54" (c. 80 mm x 130 mm x 90 mm) ¹
Weight	c. 3 oz (85 g) ¹
Therapy pressure range	4 cm H ₂ O - 30cm H ₂ O (4 hPa - 30hPa)
Tube connection: tapered connection to ISO 5356-1	male Ø 0.87" (22 mm)
Pressure measurement ports	Ø 0.16" (4 mm)
Temperature range Operation Storage	+41 °F to +104 °F (+5 °C to +40 °C) - 4 °F to +158 °F (-20 °C to +70 °C)
Dead space Size S Size M Size L	80 ml (4.88 in ³) 100 ml (6.10 in ³) 130 ml (7.93 in ³)
Flow resistance at 50 l/min at 100 l/min	0.2 cm H ₂ O (0.2 hPa) 0.26 cm H ₂ O (0.26 hPa)
Quoted two-figure noise emission value to ISO 4871: - sound pressure level - sound power level - uncertainty factor	15 dB(A) 23 dB(A) 3 dB(A)
Service life	up to 12 months ²

- 1 Depending on size and variant
- 2 The materials of the mask will age if they are exposed to aggressive detergents, for example. In individual cases, therefore, it may be necessary to replace mask parts sooner.

The right to make design modifications is reserved.

9.2 Materials

Mask part	Material
Cap for pressure measurement ports	Silicone
Mask cushion, forehead cushion	Silicone and silicone gel, silicone coating
Mask frame, elbow	Polycarbonate
Retaining ring	Polypropylene, TPE
Headgear clip, rip-cord clip	Polyoxymethylene
Forehead support, rotating sleeve	Polyamide
Headgear	Lycra, polyester, polyurethane, UBL loop

All parts of the mask are free from PVC. This device is not made with natural rubber latex.

9.3 Characteristic pressure/flow curve

The characteristic pressure/flow curve shows outlet flow rate as a function of therapy pressure.

