

Z1[®] CPAP System

CONTINUOUS POSITIVE AIRWAY PRESSURE SYSTEM

User Guide

Human Design Medical, LLC



Z1[®]

User Guide
English

Contents

Welcome to Your Z1 CPAP System.....	2
Owner/User Responsibility.....	2
Healthcare Provider Responsibilities.....	2
Replacement Z1 Parts and Supplies.....	2
Terms Used in this User Guide.....	3
Medical Information.....	3
Z1 Warnings and Cautions.....	4
Battery Warnings and Cautions.....	7
Getting to Know Your Z1 CPAP System.....	8
Package Contents.....	8
Z1 CPAP Device.....	9
Power Supply (AC to DC Power Adapter).....	9
Tube Adapter.....	9
CPAP Tube.....	9
End Cap.....	9
Filter.....	9
USB Micro Cable.....	9
PowerShell (Optional Accessory).....	9
Initial Set Up.....	10
Unpacking the Z1 Box.....	10
Assembling and Powering Up.....	11
Using Your Z1.....	13
Starting and Stopping Treatment.....	14
Choosing Between Z-Breathe Settings.....	15
Programming Ramp Mode.....	15
User Software.....	16
Charging the Battery (PowerShell Only).....	16
Care.....	17
Inspections.....	17
Cleaning.....	17
Reminder Alert (Air Leak Detection).....	18
Fault Conditions.....	19
USB Firmware Upgrade.....	19
Troubleshooting.....	19
Guidance and Manufacturer's Declaration.....	21
Technical Specifications.....	25
Servicing.....	27
Limited Warranty.....	27
Contact Information.....	28
FAA Compliance.....	29
Product Registration.....	31

Z1®, PowerShell®, Human Design Medical®, and the HDM logo (HDM logo) are registered trademarks of Human Design Medical, LLC.

Patent Pending. © Copyright 2015, Human Design Medical, LLC. All rights reserved.

Printed in the USA.

Welcome to Your Z1 CPAP System

Thank you for choosing the **Z1 CPAP System** from *Human Design Medical*– designed, engineered, and assembled in the USA with you in mind.

The **Z1** is specially designed with these features:

- ZBreathe™ – the **Z1** automatically reduces the air pressure in the mask to relieve pressure when you exhale and to level out the pressure differences in your natural breathing pattern.
- Leak Compensation – the **Z1** automatically compensates for minor air leakage helping ensure the proper treatment pressure is maintained.
- Auto Altitude Adjustment – the **Z1** adjusts to altitudes up to 8000 ft above sea level.
- Air Travel – The **Z1** adjusts to an airplane's cabin pressure and is approved for use on airplanes.
- Upgradable Operating System– the **Z1** firmware and software can be easily updated via the **USB Cable** and your computer.

This User Guide will help you take advantage of the features and capabilities of this amazing portable CPAP device. Please read this User Guide carefully before using your **Z1**.

Owner/User Responsibility

The owner/user of the **Z1 CPAP System** is responsible for reading and understanding this User Guide. The user is responsible for any injury or damage that results from:

- Operation of the **Z1** other than in accordance with the operating instructions contained in the User Guide supplied.
- Unauthorized maintenance or modifications to the device or attached accessories.

Healthcare Provider Responsibility

Your healthcare provider is responsible for explaining contraindications and instructions for use to the patients/users.

Replacement Z1 Parts and Supplies

Use only genuine **Z1** replacement filters, parts and supplies. Replacement filters, parts and supplies can be purchased from Human Design Medical at 1-855-436-8724 [1-855-HDMUSA4] or online at www.hdmusa.com. Use of unauthorized filters, parts or replacement supplies can damage the device and void the warranty.

Terms Used in this User Guide

This User Guide contains special terms and icons that appear in the text to draw your attention to specific and important information.

 **WARNING** alerts you to possible injury or hazard.

 **CAUTION** explains special measures for the safe and effective use of the device.

NOTE is an informative or helpful note.

Medical Information

Indications for Use

Your **Z1 CPAP System** is a single user, reusable device that provides continuous positive airway pressure (CPAP) to support treatment of adults weighing over 66 lbs (30 kg) with obstructive sleep apnea (OSA).

Contraindications

Positive airway pressure therapy may be contraindicated in some individuals with the following pre-existing conditions:

- Severe bullous lung disease
- Pneumothorax
- Pathologically low blood pressure
- Dehydration
- Cerebrospinal fluid leak, recent cranial surgery, or trauma.

Adverse Effects

Users should report unusual chest pain, severe headache, or increased breathlessness to their prescribing physician. An acute upper respiratory tract infection may require temporary discontinuation of treatment.

The following side effects may arise during the course of therapy with CPAP devices:

- Drying of the nose, mouth, or throat
- Eye irritation
- Nosebleed
- Bloating
- Skin rashes
- Ear or sinus discomfort.

Z1 Warnings and Cautions

WARNINGS:

- Read the entire User Guide before using your **Z1**. Consult your health care provider if there is any part of this User Guide you do not understand.
- US Federal law restricts this device to sale by or on the order of a physician.
- Use your **Z1** and its accessories only for their intended use as described in this User Guide and as directed by your physician, clinician or health care provider.
- The **Z1** is not approved for use with oxygen. Do not use supplemental oxygen or any other type of supplementary gas with your **Z1**. Do not connect supplementary oxygen or other gas to any accessory or patient interface which is connected to your **Z1**.
- If you notice any unexplained changes in the performance of your **Z1** or your **Z1** is making unusual or harsh sounds, or if the **Z1** or **Power Supply** are dropped or mishandled, discontinue use and contact the Human Design Medical Service Center at 1-855-436-8729 [1-855-HDMUSA9].
- If your **Z1**, **Power Supply**, **PowerShell** or **Battery** is dropped or mishandled, or if water is spilled into an enclosure, or if an enclosure is broken, discontinue use and contact the Human Design Medical Service Center at 1-855-436-8729 [1-855-HDMUSA9].
- A mask is not provided. Your **Z1** should only be used with masks and connectors recommended by your physician, clinician, respiratory therapist or health care provider.
- Your **Z1** is intended to be used with CPAP masks (or connectors) which have vent holes to allow continuous flow of air out of the mask. When your **Z1** is turned on and functioning properly, new air from the **Z1** flushes the exhaled air out through the mask vent holes. However, when the **Z1** is not operating properly (e.g., at low pressure) or the **Z1** is off, insufficient fresh air may be provided through the mask and the exhaled air may be rebreathed. Rebreathing exhaled air for longer than several minutes can, in some circumstances, lead to suffocation. This applies to most CPAP devices. Your health care provider will recommend a mask and air tubing to suit your needs. The **Z1** supports several CPAP mask types including nasal masks, full face masks, and nasal prongs that meet the ISO 17510-2 standard.
- Do not use your **Z1** with a mask unless the **Z1** is turned on. Once the mask is fitted, confirm that air is flowing from your **Z1**.
- Do not block the vent hole or holes in the mask. Follow the mask manufacturer's instructions for proper use of the mask.
- In the event of a power failure or machine malfunction, remove the mask immediately.
- At low pressures some exhaled gases may remain in the mask.
- **Electrocution Hazard** – Your **Z1** is an electrical device, and as such, you should not immerse your **Z1**, **Power Supply**, **PowerShell** or **Battery** in water. Always unplug your

Z1 and its accessories before cleaning (and clean only as instructed in this User Guide) and make sure your **Z1** and its accessories are dry before plugging back in.

- Before use, make sure the power cord and plug are in good condition and that the cord is not damaged.
- Do not use bleach, chlorine, alcohol, or aromatic-based solutions, moisturizing or antibacterial soaps or scented oils to clean your **Z1**, **Power Supply**, **PowerShell** or **Battery**. These solutions may create a shock hazard, cause damage and reduce the life of these items.
- **Explosion Hazard** — Do not use or store your **Z1**, **Power Supply**, **PowerShell** or **Battery** in the vicinity of flammable anesthetics or oxygen.
- Do not use your **Z1** near toxic or harmful vapors.
- Do not drop your **Z1** or any of its accessories or expose it to any crushing forces. Should your **Z1** be dropped and fail to operate properly, contact the Human Design Medical Service Center at 1-855-436-8729 [1-855-HDMUSA9] before using the **Z1** for treatment.
- Do not insert any object into any tubing or opening of your **Z1** except as described in this User Guide.
- Do not operate your **Z1** in any area which may block its air intake. Blocking the **CPAP Tube** and/or air inlet of your **Z1** while in operation could lead to overheating of the **Z1**.
- If you put the **Z1** on the floor, make sure the area is free from dust and clear of bedding, clothes or other objects that could block the air inlet or cover the **Power Supply** unit.
- Only store or transport the **Z1** and accessories within the storage and transport temperature, humidity and altitude conditions specified in the Technical Specifications section of this User Guide.
- Do not operate your **Z1**, **Power Supply**, **PowerShell** or **Battery** in an area which may cause overheating.
- Do not cover the **Power Supply**, **PowerShell** or **Battery** with any object or material which would cause them to overheat.
- Keep the power cord, **Power Supply**, **Battery** and **Z1** away from hot or flammable surfaces, gases or materials.
- Do not open your **Z1** or tamper with its accessories. There are no user serviceable parts inside. Repairs and servicing should only be performed by an authorized Human Design Medical service agent.
- Only power the **Z1** with the Human Design Medical **Power Supply** (AC-to-DC power adapter, HD60-6010) or the optional Human Design Medical **PowerShell** with Human Design Medical **Battery**. Do not use any other AC adapters, batteries, or other power sources to power the **Z1**. Do not use the Human Design Medical **Power Supply**, **PowerShell** or **Battery** to power any device other than the **Z1**.

- Your **Z1** should only be used with standard or slim style CPAP air tubing as recommended by your physician, clinician or health care provider.
- Do not leave long lengths of air tubing around the top of your bed. The tube could twist around your head or neck while you are sleeping.
- Do not connect or insert any device, cable or articles into the Micro USB or Micro SD ports of your **Z1** except as described in this User Guide. Connecting other devices could result in injury to you or damage to the **Z1** and void the warranty.
- Do not locate your **Z1** in an unapproved place or where the air intake can be blocked during treatment. This will lead to overheating of the **Z1**. If a blocked intake should occur during operation, the unit may stop supplying pressurized air and cause a fault condition. Refer to “Troubleshooting” in this User Guide to interpret this fault and instructions for corrective action.
- The **Z1** is designed to deliver pressures from 4 to 20 cm H₂O. In the unlikely event of certain fault conditions, pressures of up to 30 cm H₂O are possible.
- Blocking the **CPAP Tube** while in operation could lead to overheating of the **Z1**.
- In the clinical environment, any personal computer that is used with your CPAP system must be at least 5 feet (1.5 m) away from, or at least 8 feet (2.5 m) above, the patient. It must also comply with the relevant test standard. For personal computers the international standard is IEC 60950 or equivalent.

CAUTIONS:

- Be careful not to place your **Z1** where it can be bumped or where someone is likely to trip over the power cord.
- Make sure your **Z1**, **Power Supply**, **PowerShell** and **Battery** are kept clean, dry, and free of dust.
- Always make sure the power cord and plugs are in good condition and the equipment is not damaged before use.
- Make sure the area around your **Z1** and accessories is dry and clean.
- During partial (below rated minimum voltage) or total power failure, therapy pressures will not be delivered. When power is restored, your **Z1** will enter standby mode and all prior settings will be retained in memory.
- Follow the storage and cleaning instructions provided with your **CPAP Tube** and mask.
- The air filter should be changed at intervals specified in this User Guide. Accumulation of filtered particles over time can reduce the efficiency and shorten the life of any CPAP device, including the **Z1**. Replacement filters are available at 1-855-436-8724 [1-855-HDMUSA4] or online at www.hdmusa.com.
- Do not wash the air filter. The air filter is not washable or reusable.
- The **End Cap** protects the **Z1** in the event of a minor collision. Always ensure that the **End Cap** is securely fitted in accordance with instructions at all times. The **Z1** may not operate if the **End Cap** is not properly installed.

- The temperature of the airflow for breathing produced by CPAP devices can be higher than the temperature of the room. This is true of all CPAP devices. Caution should be exercised when using your **Z1** at room temperatures warmer than 90°F (32°C).
- Only operate the **Z1** and accessories within the operating temperature, humidity and altitude conditions specified in the Technical Specifications section of this User Guide.
- Only store or transport the **Z1** and accessories within the storage and transport temperature, humidity and altitude conditions specified in the Technical Specifications section of this User Guide.
- Damage to the **CPAP Tube** may result in air leaks. If this occurs, stop using the damaged **CPAP Tube** and replace immediately.

Battery Warnings and Cautions

The **PowerShell** comes with a removable **Lithium Ion Battery**. Careful attention must be paid to the warnings and cautions described below relating to the **Battery**. Misusing the **Battery** may cause the **Battery** to get hot, rupture, ignite and cause serious injury.

WARNINGS:

- Do not place the **Battery** in fire or heat the **Battery**.
- Do not install the **Battery** backwards so that the polarity is reversed.
- Do not connect the positive terminal and the negative terminal of the **Battery** to each other with any metal object (such as wire).
- Do not carry or store the **Battery** together with necklaces, hairpins, or other metal objects.
- Do not pierce the **Battery** with nails, strike the **Battery** with a hammer, step on the **Battery** or otherwise subject it to strong impacts or shocks.
- Do not solder onto the **Battery**.
- Do not expose the **Battery** to water or salt water, or allow the **Battery** to get wet.
- Do not disassemble or modify the **Battery**. The **Battery** contains safety and protection devices which, if damaged, may cause the **Battery** to generate heat, rupture or ignite.
- Do not place the **Battery** on or near fires, stoves or other high-temperature locations. Do not place the **Battery** in direct sunlight, or use or store the **Battery** inside cars in hot weather. Doing so may cause the **Battery** to generate heat, rupture or ignite. Using the **Battery** in this manner may also result in a loss of performance and a shortened life expectancy.
- Immediately discontinue use of the **Battery** if, while using, charging or storing the **Battery**, the **Battery** emits an unusual smell, feels hot, changes color, changes shape or appears abnormal in any other way. Contact the Human Design Medical Service Center at 1-855-436-8729 [1-855-HDMUSA9] if any of these problems are observed.
- Do not place the **Battery** in microwave ovens, high-pressure containers, or on induction cookware.

- In the event that the **Battery** leaks and the fluid gets into one's eye, do not rub the eye. Rinse well with water and immediately seek medical care. If left untreated the battery fluid could cause damage to the eye.
- Only charge the **Battery** with the supplied Human Design Medical **PowerShell** and the supplied Human Design Medical **Power Supply**. Do not use any other removeable battery charger, AC adapter, or other device to charge the **Battery**.
- Do not attach the **Battery** directly to a vehicle cigarette lighter or to the **Power Supply** plug.
- Do not continue charging the **Battery** if it does not recharge within the specified charging time. Doing so may cause the **Battery** to become hot, rupture or ignite.
- Remove the **Battery** from the **PowerShell** if the **Z1** is not likely to be used for some time. Do not use the **Battery** to power any device other than the **Z1**.
- Only use or charge the **Battery** within the operating temperature, humidity and altitude conditions specified in the Technical Specifications section of this User Guide.
- Only store or transport the **Battery** within the storage and transport temperature and humidity conditions specified in the Technical Specifications section of this User Guide.

 **CAUTION:**

- When the **Battery** is worn out, insulate the terminals with adhesive tape or similar materials before disposal.

Getting to Know Your Z1 CPAP System

Package Contents

Description	Human Design Medical Part #	Z1 Base Model	Z1 Unplugged
Z1 CPAP Device	HD60-1000	✓	✓
Power Supply & Cord	HD60-6010	✓	✓
USB A to Micro B Cable	HD60-6300	✓	✓
CPAP Tube Adapter	HD60-5020	✓	✓
48" Slim Style CPAP Tube	HD60-2010	✓	✓
End Cap	HD60-5011	✓	✓
Filter (2-1 installed in Z1, 1 in box)	HD60-3020	✓	✓
Z1 Getting Started Guide	HD40-0005	✓	✓
User Guide	HD40-0007	✓	✓
Overnight Battery	HD60-7050		✓
Battery Shuttle	HD60-7030		✓
PowerShell	HD60-7020		✓
PowerShell Getting Started Guide	HD40-0012		✓

Z1 CPAP Device

The **Z1** supplies continuous positive airway pressure and can be programmed to fit the patient's prescriptive needs.

Power Supply (AC to DC Power Adapter)

The **Power Supply** provides power to the **Z1**. It takes AC power (voltage ranging from 100-240 volts) from a wall outlet and converts it to DC voltage to power the **Z1**. The **Power Supply** can be used with international power sources provided the appropriate plug adapter is used.

Tube Adapter

The **Tube Adapter** attaches the **CPAP Tube** to the **Z1**.

CPAP Tube

The **Z1 System** is provided with a 4 ft slim style **CPAP Tube**. The **CPAP Tube** connects the **Z1** to your mask. Always consult with your physician or health care provider regarding the selection of tubing for your treatment. Follow the instructions provided with the tubing. Replacement tubing can be purchased from Human Design Medical at 1-855-436-8724 [1-855-HDMUSA4] or online at www.hdmusa.com.

End Cap

The **End Cap** attaches to the air intake end of the **Z1** and houses the **Filter**.

Filter

The **Z1** uses a specially designed filter. The material has been specifically chosen for the **Z1** and has been designed to be much larger than other CPAP filters. The unique shape of the **filter** fits into the **End Cap** of the **Z1**, which was designed to allow for more effective filter surface area.

For proper operation of the **Z1**, the **Filter** should be replaced monthly or more often if necessary.

USB Micro Cable

The **USB Cable** allows the **Z1** to communicate with a computer to collect and view user data.

PowerShell (Optional Accessory)

The **PowerShell** houses both the **Z1** and the **Battery** which allows temporary usage of the **Z1** without the **Power Supply**. It can be purchased at 1-855-436-8724 [1-855-HDMUSA4] or online at www.hdmusa.com.

NOTE: Replacement **Filters** can be purchased from Human Design Medical at 1-855-436-8724 [1-855-HDMUSA4] or online at www.hdmusa.com.

Initial Set Up

Unpacking the Z1 Box

You will need to perform a few minor setup steps before using your new **Z1**. The instructions below will guide you through the setup process. Some of the steps outlined below may have been performed by your health care provider prior to delivering the **Z1** to you. If you have any questions or problems as you go through the setup process, please call Human Design Medical Customer Service at 1-855-436-8729 [1-855-HDMUSA9] for assistance. Human Design Medical wants your user experience with the **Z1** to be trouble and frustration free.

1. Carefully remove the contents of the box.
2. Some of the **Z1** components have their own packaging material. Remove this material carefully. Avoid using anything sharp when opening the packaging.
3. Carefully inspect all contents against the Package Contents list on page 8 to assure all components are present. Keep in mind that your health care provider might have completed some of the setup steps prior to delivery, so if a component appears to be missing, check to see if it has already been connected. Also inspect all contents to ensure there is no obvious or visible damage or defects. If you have any concerns or questions, contact Human Design Medical Customer Service at 1-855-436-8729 [1-855-HDMUSA9], or your service or health care provider before use.
4. Place all the components in an area where you can easily access the **Z1** for set up and programming.

⚠ WARNING: Do not use this product if you have any concerns about the condition of the contents or if there are any missing parts.

The contents of the **Z1** box includes the following:

Z1 Base Model



Z1 Unplugged

Includes everything that comes with the **Z1** Base Model, plus:



Assembling and Powering Up

Filter and End Cap

Your Z1 comes with the first filter already installed. Replacement filters may be installed as follows:

1. Remove the **Filter** out of the **End Cap**.

NOTE: To remove the **End Cap**, squeeze firmly on the sides of the **End Cap** and pull it away from the **Z1**.

2. Pull used filter out of the **End Cap**.
3. Remove new **Filter** from its packaging.
4. Insert the new **Filter** into the **End Cap**, aligning the arched side of the **Filter** with the top of the **End Cap**.

Ensure the **Filter** covers all holes in the **End Cap**, so that all air entering the **Z1** passes through the **Filter** and no air bypasses the **Filter**.

5. Press the **End Cap** onto the **Z1**. (Figure 1)



Figure 1

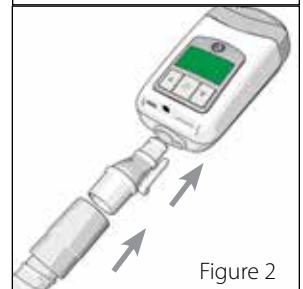

Figure 2

Tube Adapter, CPAP Tube and Mask

1. Connect one end of the **CPAP Tube** to the round end of the **Tube Adapter** then insert the other end of the **Tube Adapter** into the outlet of the **Z1**. (Figure 2)
2. Connect the other end of the **CPAP Tube** to the mask.
3. Ensure all connections are tight to avoid air leaks. (Figure 3)

Power Supply

⚠ WARNING: The **Z1** must only be used with the Human Design Medical **Power Supply** (or the optional Human Design Medical **PowerShell** with Human Design Medical **Battery**). DO NOT use any other power source with the **Z1**.

⚠ CAUTION: Make sure the AC power cord IS NOT plugged into an AC power outlet before continuing to the next step.

1. Plug the AC power cord into the AC Adapter.
2. Plug the AC power cord into a wall outlet.
3. Plug the AC Adapter into the **Z1**. (Figure 4)
4. The **Z1** will power up and cycle through a series of startup displays.
5. After about 10 seconds, the **Z1** will enter standby mode. The display will read 0.0. (Figure 5)

NOTE: The **Z1** display will be active whenever the device is receiving power.

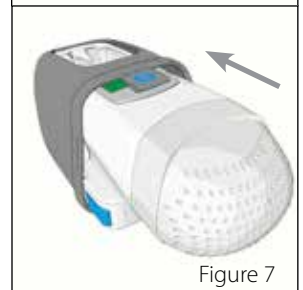
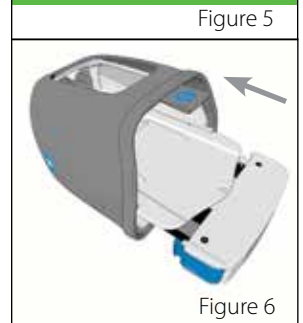
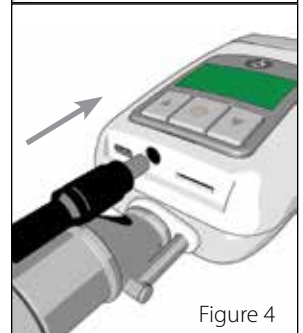
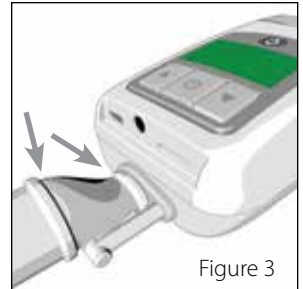

PowerShell and Battery (Available Separately or as Part of Z1 Unplugged)

⚠ WARNING: The **Z1** must only be used with the optional Human Design Medical **PowerShell** with Human Design Medical **Battery** (or the Human Design Medical **Power Supply**). DO NOT use any other power source with the **Z1**.

1. Slide the **Battery** with the attached **Shuttle** into the lower bay of the **PowerShell** until the **Shuttle** clicks into place. (Figure 6)

NOTE: The **Battery** can be removed from the **PowerShell** by pressing the two blue buttons on the **Battery Shuttle** and sliding the **Battery** out.

2. Slide the **Z1** all the way into the upper bay of the **PowerShell** until you hear a "click" sound, indicating the **Z1** has locked into place. (Figure 7)

⚠ CAUTION: Insert the **Z1** carefully ensuring the power barrel connector slides into the power input on the **Z1**.

NOTE: The *Z1* can be removed from the *PowerShell* by pressing the two [▶] symbols on the sides of the *PowerShell* and sliding the *Z1* out.

- The *Z1* will power up and cycle through a series of startup displays.
- After about 10 seconds, the *Z1* will enter standby mode. The display will read 0.0. (Figure 8)

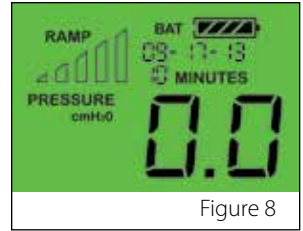

NOTE: Remove the *Battery* from the *PowerShell* when the *Z1* is not in use, unless the *Power Supply* is plugged into the *PowerShell* to charge the *Battery*. Otherwise the *Z1* and *PowerShell* will drain the battery completely within 2-3 days.

Using Your Z1

1 Treatment Pressure Display

The current treatment pressure is shown on the LCD display. Once set, the prescribed treatment pressure will be retained in the *Z1*'s memory even during loss of power. For example, a treatment pressure setting of 10.0 cm H₂O is displayed in Figure 9.

2 Ramp Progress & 3 Ramp Time Remaining Indicators

Ramp Mode allows you to gradually acclimate to the prescribed treatment pressure. Ramp Mode gradually increases the pressure from a low initial starting pressure to the prescribed treatment pressure over a programmed interval of time. See "Programming Ramp Mode".

If you program the *Z1* for Ramp Mode, the Ramp Progress and Ramp Time Remaining indicators will appear on the LCD display. For example, Figure 9 indicates that the ramp is just over half complete, with a ramp time remaining of 10 minutes.

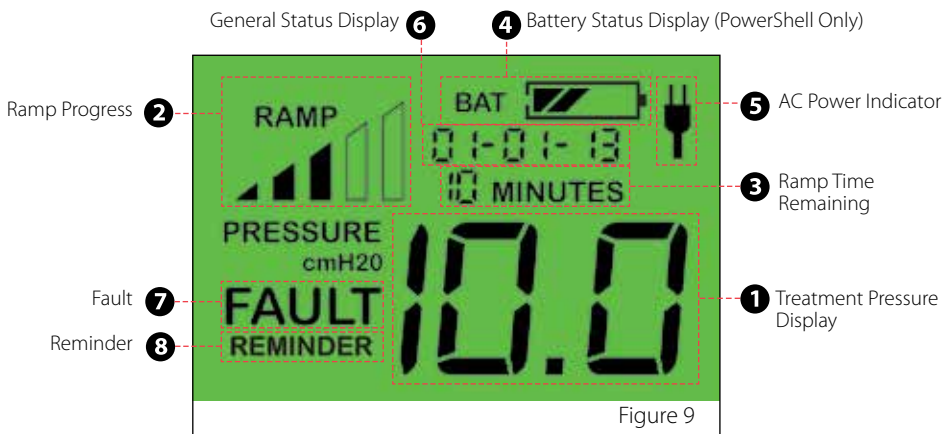

4 Battery Status Display

This icon is displayed when the optional **PowerShell** and **Battery** are connected. The level of charge remaining on the **Battery** is indicated by the number of solid bars in the icon. The bars flash when the **Battery** is charging. For example, the icon shown in Figure 9 indicates that the **Battery** has between 25-50% of charge remaining. Make sure the **Battery** is fully charged before each use.

Number of Solid Bars	Charge Remaining
1	10-25%
2	25-50%
3	50-75%
4	75-100%

5 AC Power Indicator

This icon is displayed when the **Z1** is connected to an AC power outlet via the **Power Supply**.

6 General Status Display

In Standby Mode, this display field alternates between a display of the current date, the current function mode and the Z-Breathe setting. During treatment and while setting treatment parameters, this display field shows the currently selected function mode (CPAP) and Z-Breathe setting (1, 2 or 3). The General Status Display field may also give notification of certain events which will NOT prevent prevent the Z1 from operating normally but may need to be addressed by the user.

7 FAULT

"FAULT" is displayed if one of several conditions has occurred that require your attention. See Fault Conditions (page 19) for explanations of the FAULT codes.

8 REMINDER

"REMINDER" is displayed if there is excessive air leakage. See Reminder Alert (page 18) for an explanations of REMINDER conditions.

Starting and Stopping Treatment

1. Press the **Start/Stop Button** on the **Z1** to initiate treatment using the pre-programmed prescription setting. The Treatment Pressure Display will show the actual pressure being delivered at all times. If the Ramp Mode has been programmed, the ramp start pressure will be displayed upon pressing the **Start/Stop Button** and the indicated pressure will rise as the **Z1** ramps up to prescribed treatment pressure. If the incorrect pressure is displayed, contact your health care provider before commencing CPAP therapy. (Figure 10)

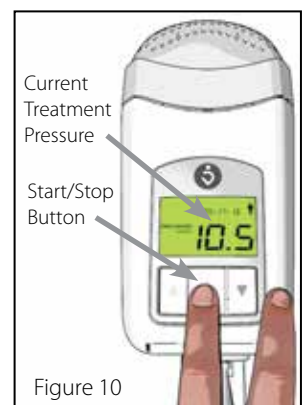

CAUTION (When using the *PowerShell* Only): Make sure your *Battery* is fully charged before commencing CPAP therapy using the *PowerShell*. The battery life of a fully charged battery in the *PowerShell* is typically 8 hours or longer and treatment will terminate when the charge is expended. To recharge the Battery, see "Charging Battery".

2. Press the **Start/Stop Button** a second time to stop treatment.

Choosing Between Z-Breathe™ settings

The **Z-Breathe** setting of 1-3 is indicated by the number following the CPAP designation on the LCD screen. For example CPAP-3 means the CPAP mode with a **Z-Breathe** setting of 3 (Figure 11) To set the Z-Breathe setting, press and hold down the **Up Arrow Button** and **Down Arrow Button** simultaneously while in the Standby mode (pressure of "0.0" indicated on the display). Once you see the Function Mode indicator flashing on the LCD screen, you can select the desired **Z-Breathe** setting using the **Up Arrow Button** and **Down Arrow Button**. After you have made your selection, press and hold the **Start/Stop Button** to save it.

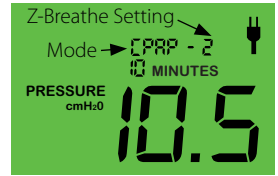

Figure 11

Your selected setting for the **Z-Breathe Algorithm** will be retained in the memory of your **Z1** unit after it is turned off. The currently selected **Z-Breathe Algorithm** setting will be displayed when the **Z1** is delivering treatment pressure.

Z-Breathe is a proprietary algorithm engineered in the **Z1** to smooth out the breathing cycle while enjoying the benefits of CPAP treatment. Typically users experience pressure swings while breathing on a CPAP device. Pressure swings occur as a spike in pressure during exhalation and a drop in pressure during inhalation. **Z-Breathe** is designed to minimize the impact of spikes and drops while keeping the pressure constant, thereby delivering more comfortable therapy.

Pressure swings can vary between users due to lung capacity and other factors. For this reason we have created 3 levels of **Z-Breathe** to accommodate individual users' preferences:

- 1 offers mild pressure swing relief
- 2 is the Default Setting and offers moderate pressure swing relief
- 3 is the most aggressive setting for pressure swing relief

Programming Ramp Mode

Some users find it comforting to acclimate to CPAP therapy each session. This can be accomplished by programming the Ramp Mode which allows you to start with a low initial pressure and gradually increase to the prescribed treatment pressure.

Setting Ramp Time

When the **Z1** is in standby mode, press and hold the **Up Arrow Button** for approximately 3 seconds until the "00 MINUTES" value flashes. While it is flashing, repeatedly press either the **Up** or **Down Arrow Buttons** to increase or decrease the ramp time in 5 minute increments. (Figure 12) Set the ramp time to "00 MINUTES" to disable the Ramp Mode.



Figure 12

When the desired ramp time value is reached, press and hold the **Start/Stop Button** for approximately 3 seconds to save your ramp time setting (this setting will be saved even when the **Z1** is not powered). The **Z1** will return to standby mode. To return to standby mode without saving the new setting, press and release the **Start/Stop Button** momentarily instead of holding it down.

NOTE: Ramp Time must be set to a minimum of 5 minutes prior to attempting to program Ramp Start Pressure or the change to Ramp Start Pressure will not take effect and "FAIL 2" will be shown in the General Status Display field.

Setting Ramp Start Pressure

Press and hold the **Down Arrow Button** for 3 seconds until the ramp start pressure value flashes. While flashing, repeatedly press either the **Up** or **Down Arrow Buttons** to increase or decrease the ramp start pressure by 0.5 cm H₂O increment. (Figure 12) Ramp start pressure must be lower than prescribed pressure.

When the desired value for ramp start pressure is reached, hold down the **Start/Stop Button** for approximately 3 seconds to save your setting. The **Z1** will return to standby mode. To return to standby mode without saving the new setting, press the **Start/Stop Button** momentarily instead of holding it down.

User Software

Human Design Medical provides User Software for data viewing which may be downloaded from the Human Design Medical website to any Windows computer. A separate user guide for this software is available for download at the Human Design Medical website, www.hdmusa.com. This software can be used to upgrade the **Z1** firmware as new releases are made available.

Charging the Battery (PowerShell Only)

WARNING: Only charge the **Battery** with the supplied Human Design Medical **PowerShell** and the supplied Human Design Medical **Power Supply**. Do not use any other battery charger, AC adapter, or other device to charge the **Battery**.

With the **Z1** and the **Battery** fully inserted into the **PowerShell**, plug the **Power Supply** into the **PowerShell** as shown and into a power outlet. (Figure 13)

CAUTION: Make sure your **Battery** is fully charged before commencing CPAP therapy using the **PowerShell**. The battery life of a fully charged battery in the **PowerShell** is typically 8 hours or longer, after which treatment will terminate. To recharge the **Battery**, see "Charging the Battery".

Ensure the **Z1** is in standby mode (display reads 0.0). The **Battery** will not charge unless the **Z1** is in standby mode. The **Battery** status indicator on the **Z1** will flash when the **Battery** is charging. The number of solid bars indicates the current level of charge. (Figure 14)



Figure 13

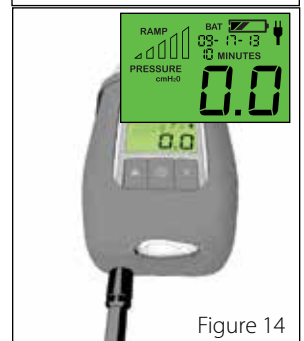

Figure 14

The battery status indicator will stop flashing when the **Battery** is only 90% charged. Typically it will take 10 hours to fully charge the battery to 100%. After a few minutes, the backlit display will turn off. This is to conserve power. It does not indicate that the battery is fully charged.

NOTE: The battery will not charge if you are using your Z1 CPAP at the same time.

Care

The **Z1 System** needs periodic care. It is the user's responsibility to be aware of the following items for care:

- Inspections
- Cleaning
- **Filter** Replacement
- **CPAP Tube** Replacement
- Reminders and Fault Conditions

Inspections

Before each use carefully inspect the **Z1**, **CPAP Tube**, **Filter**, and mask for signs of wear, damage or discoloration. Contact Human Design Medical for replacement parts at 1-855-436-8724 [1-855-HDMUSA4] or online at www.hdmusa.com.

Cleaning

Regular cleaning should be performed in accordance with the instructions below.

⚠ WARNING: This device can expose you to electrocution. Do not immerse the **Z1**, **Power Adapter**, **Power Cord** or **Battery** in water. Always unplug these devices before cleaning (only as instructed in this User Guide) and make sure they are dry before plugging back in.

⚠ CAUTION: Do not use bleach, chlorine, alcohol, or aromatic-based solutions, moisturizing or antibacterial soaps or scented oils to clean the **Z1**. Never attempt to clean the **Power Adapter**, **PowerShell**, **Battery** or accessories with any of these solutions. These solutions may create a shock hazard, cause damage and reduce the life of these products.

Daily

1. Remove the **CPAP Tube** and the mask from the **Z1**.
2. Wash the **CPAP Tube** in warm water using mild detergent.
3. Rinse thoroughly, hang, and allow to dry.
4. Before next use, reconnect the **CPAP Tube** and the **Tube Adapter** to the **Z1** and mask.

NOTE: Soaking the CPAP Tube in water for longer than 10 minutes may shorten the life of the tube.

Every 90 days

The CPAP tube should be replaced every 90 days or earlier if it becomes discolored, cracked or damaged.

 **CAUTION:** Do not use bleach, chlorine, alcohol, or aromatic-based solutions, moisturizing or antibacterial soaps or scented oils to clean the CPAP tube. Never attempt to clean the CPAP tube with any of these solutions. These solutions may create a shock hazard, cause damage and reduce the life of the CPAP tube.

 **CAUTION:** Prolonged exposure to sunlight may cause the CPAP Tube to discolor and degrade

As Needed

1. Clean the exterior of the **Z1** with a soft damp cloth and mild detergent and wipe clean. Never submerge the **Z1** in water. Do not allow soap or water to enter the **Z1**.

NOTE: Replacement CPAP tubes may be purchased directly from Human Design Medical at 1-855-436-8724 [1-855-HDMUSA4] or online at www.hdmusa.com.

Filter Replacement

The **Filter** should be inspected weekly for holes and blockage by dirt and dust, and should be replaced every month (or more often if necessary). The **Filter** is accessed by removing the **End Cap** as described in "Assembling and Powering Up: **Filter** and **End Cap**".

NOTE: The **Z1** uses a specially designed Filter that is only available from Human Design Medical at 1-855-436-8724 [1-855-HDMUSA4] or online at www.hdmusa.com.

 **WARNING:** Do not attempt to use any air filter which is not supplied by Human Design Medical for the **Z1**. The **Z1** is designed to only work with approved materials. A filter which is not approved may cause damage to the **Z1** from overheating.

 **CAUTION:** Do not operate the **Z1** without the **Filter**. The **Z1** must operate with a filter installed; failure to do so may damage the **Z1** and allow impurities into the respiratory system.

Reminder Alert (Air Leak Detection)

"REMINDER" is displayed on the LCD screen to indicate an excessive air leak. This could be because you are not wearing your mask. Placing the mask on your face should remove REMINDER from the display. If you are wearing the mask and REMINDER is displayed check the following connections for air leaks:

- **Tube Adapter** to **Z1**
- **CPAP Tube** to **Tube Adapter**
- **CPAP Tube** to mask
- Mask to face (adjust position of mask and headgear to eliminate the air leak)

Fault Conditions

The **Z1** has the ability to detect operational problems and will display the word **FAULT** on the LCD screen. (Figure 15)

The LCD screen should be checked for any **FAULT** messages and visible damage daily.

A fault condition is indicated when the word “**FAULT**” is displayed accompanied by a two digit flashing number in place of the pressure reading.

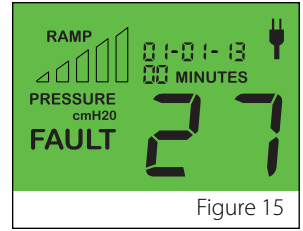

Figure 15

The table below provides a listing of fault codes and recommended actions to be taken by the user.

Fault Code	Explanation	Action
21 Flashing	Treatment pressure not programmed	Discontinue use and contact your health care provider or HDM.*
27 Flashing	Overheating	Discontinue use and contact your health care provider or HDM.*
32 Flashing	Over current	Discontinue use and contact your health care provider or HDM.*
33 Flashing	Over pressure	Discontinue use and contact your health care provider or HDM.*

*Human Design Medical Service Center at 1-855-436-8729 [1-855-HDMUSA9].

USB Firmware Upgrade

Z1 firmware upgrades can be downloaded via a link on support.hdmusa.com. Complete instructions can be found on the web site. To upgrade the firmware on your **Z1** connect the **Z1** to your PC with the included USB cable. The USB firmware upgrade can also be used to change the date and time settings on the **Z1** by following the instructions on the web site.

Troubleshooting

Problem	Possible Causes & Solutions
No Display	<p>Power is not present. Ensure the Power Supply is connected and the power outlet has power.</p> <p>Loose connection of the Power Supply at the Z1 or loose connection of the Power Cord at the AC Adapter. Check the connections.</p> <p>Z1 is not locked into position in the PowerShell. Slide the Z1 into the PowerShell until it clicks and locks into place.</p> <p>Battery is not locked into position in the PowerShell. Slide the Battery into the PowerShell until the Battery Shuttle clicks and locks into place.</p> <p>Battery is not charged. Charge the Battery.</p>

	<p>A power supply not designed for the Z1 is connected to the Z1. Remove the power supply unit and replace with a Human Design Medical approved unit.</p>
Treatment Will Not Start	<p>Check the display for a fault condition. Refer to the Fault Codes table in "Fault Conditions". Contact the Human Design Medical Service Center at 1-855-436-8729 [1-855-HDMUSA9]</p>
Insufficient Air Flow Delivered from Z1	<p>Air filter is dirty or clogged. Replace air filter.</p> <p>Air intake is blocked. Clear blockage.</p> <p>CPAP Tube is not connected properly. Check CPAP Tube, Tube Adapter and connections to your Z1 and your mask.</p> <p>Ramp Mode is in use. Wait for air pressure to reach prescribed treatment pressure or stop treatment and adjust ramp time.</p> <p>CPAP Tube is blocked, pinched or punctured. Unblock CPAP Tube. Check the CPAP Tube for punctures. Replace a damaged CPAP Tube immediately.</p> <p>Mask and/or headgear are not positioned correctly and mask is leaking. Adjust position of the mask and headgear until leak ceases.</p> <p>Incorrect CPAP Tube selected. Do not use tubing which was not recommended by your clinician.</p> <p>Check the display for a fault condition. Refer to fault codes in "Fault Conditions".</p>
Pressure Rises Inappropriately	<p>Talking, coughing or breathing in an unusual manner. For example, avoid talking with a nasal mask on and breathe as normally as possible.</p> <p>There may be an air leak caused by improperly connected tubing. Check for leaks.</p> <p>Follow mask manufacturer's instructions.</p>
Mask Cushion is Vibrating Against the Skin and an Air Leak is Occurring	<p>Stop treatment. Remove and reposition the mask and, if necessary, adjust the headgear. Resume treatment.</p> <p>Follow mask manufacturer's instructions.</p>
Z1 Has Been Left in a Hot Environment	<p>Allow Z1 to cool before use. Disconnect the power cord and then reconnect it to restart the Z1.</p>

Electromagnetic Compatibility	The Z1 and PowerShell meet all applicable electromagnetic compatibility standards. However, if you suspect performance of the device is affected by interference from wireless sources, move the Z1 and PowerShell further away from those sources,
-------------------------------	---

Guidance and Manufacturer’s Declaration

Electromagnetic Emissions & Immunity

Medical electrical equipment needs special precautions regarding EMC and needs to be installed and put into service according to EMC information provided in this document.

The **Z1** System does not have Essential Performance within the meaning of IEC 60601-1. However, immunity testing was conducted in accordance with IEC 60601-1-2 and compliance was confirmed as summarized in this document.

Guidance and manufacturer’s declaration - electromagnetic emissions

The **Z1** CPAP System is intended for use in the electromagnetic environment specified below. The customer or the user of the **Z1** System should assure that it is used in such an environment.

Emissions test	Compliance	Electromagnetic environment — guidance
RF emissions CISPR 11	Group 1	The Z1 CPAP System uses RF energy only for its internal function. Therefore, its RF emissions are very low and are not likely to cause any interference in nearby electronic equipment.
RF emissions CISPR 11	Class B	The Z1 CPAP System is suitable for use in all establishments, including domestic establishments and those directly connected to the public low-voltage power supply network that supplies buildings used for domestic purposes.
Harmonic emissions IEC 61000-3-2	Class A	
Voltage fluctuations/ flicker emissions IEC 61000-3-3	Complies	

WARNINGS:

- The device should not be used adjacent to or stacked with other equipment. If adjacent or stacked use is necessary, the device should be observed to verify normal operation in the configuration in which it will be used.
- The use of cables and accessories (eg, humidifiers) other than those specified for the device is not recommended. They may result in increased emissions or decreased immunity of the device.

Guidance and manufacturer's declaration — electromagnetic immunity

The **Z1** CPAP System is intended for use in the electromagnetic environment specified below. The customer or the user of the **Z1** CPAP System should assure that it is used in such an environment.

Immunity test	IEC 60601 test level	Compliance level	Electromagnetic environment – guidance
Electrostatic discharge (ESD) IEC 61000-4-2	±6 kV contact ±8 kV air	±6 kV contact ±8 kV air	Floors should be wood, concrete or ceramic tile. If floors are covered with synthetic material, the relative humidity should be at least 30%.
Electrical fast transient/burst IEC 61000-4-4	±2 kV for power supply lines ±1 kV for input/output lines	±2 kV for power supply lines ±1 kV for input/output lines	Mains power quality should be that of a typical commercial or hospital environment.
Surge IEC 61000-4-5	±1 kV line(s) to line(s) ±2 kV line(s) to earth	±1 kV line(s) to line(s) ±2 kV line(s) to earth	Mains power quality should be that of a typical commercial or hospital environment.
Voltage dips, short interruptions and voltage variations on power supply input lines IEC 61000-4-11	<5 % UT (>95 % dip in UT) for 0.5 cycle 40% UT (60% dip in UT) for 5 cycles 70% UT (30% dip in UT) for 25 cycles <5% UT (>95 % dip in UT) for 5 sec	<5 % UT (>95 % dip in UT) for 0.5 cycle 40% UT (60% dip in UT) for 5 cycles 70% UT (30% dip in UT) for 25 cycles <5% UT (>95 % dip in UT) for 5 sec	Mains power quality should be that of a typical commercial or hospital environment, If the user of the Z1 Auto System requires continued operation during power mains interruptions, it is recommended that the Z1 Auto System be powered from an uninterruptible power supply or a battery.
Power frequency (50/60 Hz) magnetic field IEC 61000-4-8	3 A/m	3 A/m	Power frequency magnetic fields should be at levels characteristic of a typical location in a typical commercial or hospital environment.

NOTE: UT is the a.c. mains voltage prior to application of the test level.

Guidance and manufacturer’s declaration — electromagnetic immunity

The **Z1** Auto System is intended for use in the electromagnetic environment specified below. The customer or the user of the **Z1** Auto System should assure that it is used in such an environment.

Immunity test	IEC 60601 test level	Compliance level	Electromagnetic environment — guidance
Conducted RF IEC61000-4-6 Radiated RF IEC 61000-4-3	3 Vrms 150 kHz to 80 MHz 3 V/m 80 MHz to 2.5 GHz	3V 3V/m	Portable and mobile RF communications equipment should be used no closer to any part of the Z1 Auto System, including cables, than the recommended separation distance calculated from the equation applicable to the frequency of the transmitter. Recommended separation distance $d = 1.2 \sqrt{P}$ $d = 1.2 \sqrt{P}$ 80 MHz to 800 MHz $d = 2.3 \sqrt{P}$ 80 MHz to 2.5 GHz where P is the maximum output power rating of the transmitter in watts (W) according to the transmitter manufacturer and d is the recommended separation distance in meters (m). Field strengths from fixed RF transmitters, as determined by an electromagnetic site survey, ^a should be less than the compliance level in each frequency range. ^b Interference may occur in the vicinity of equipment marked with the following symbol: 

NOTE 1: At 80 MHz and 800 MHz, the higher frequency range applies.

NOTE 2: These guidelines may not apply in all situations. Electromagnetic propagation is affected by absorption and reflection from structures, objects and people.

^a Field strengths from fixed transmitters, such as base stations for radio (cellular/cordless) telephones and land mobile radios, amateur radio, AM and FM radio broadcast and TV broadcast cannot be predicted theoretically with accuracy. To assess the electromagnetic environment due to fixed RF transmitters, an electromagnetic site survey should be considered. If the measured field strength in the location in which the Z1 CPAP System is used exceeds the applicable RF compliance level above, the Z1 CPAP System should be observed to verify normal operation. If abnormal performance is observed, additional measures may be necessary, such as re-orienting or relocating the Z1 CPAP System.

^b Over the frequency range 150 kHz to 80 MHz, field strengths should be less than 3 V/m.

Recommended separation distances between portable and mobile RF communications equipment and the Z1 CPAP System

The Z1 CPAP System is intended for use in an electromagnetic environment in which radiated RF disturbances are controlled. The customer or the user of the Z1 CPAP System can help prevent electromagnetic interference by maintaining a minimum distance between portable and mobile RF communications equipment (transmitters) and the Z1 CPAP System as recommended below, according to the maximum output power of the communications equipment.

Rated maximum output power of transmitter W	Separation distance according to frequency of transmitter m		
	150 kHz to 80 MHz $d = 1.2 \sqrt{P}$	80 MHz to 800 MHz $d = 1.2 \sqrt{P}$	800 MHz to 2,5 GHz $d = 2.3 \sqrt{P}$
0.01	0.12	0.12	0.23
0.1	0.38	0.38	0.73
1	1.2	1.2	2.3
10	3.8	3.8	7.3
100	12	12	23

For transmitters rated at a maximum output power not listed above, the recommended separation distance d in meters (m) can be estimated using the equation applicable to the frequency of the transmitter, where P is the maximum output power rating of the transmitter in watts (W) according to the transmitter manufacturer.

NOTE 1: At 80 MHz and 800 MHz, the separation distance for the higher frequency range applies.

NOTE 2: These guidelines may not apply in all situations. Electromagnetic propagation is affected by absorption and reflection from structures, objects and people.

WARNINGS:

Please note that mobile RF communications equipment can affect medical electrical equipment.

Wireless Quality of Service for Z1 Bluetooth Communication with Z1 Mobile App

The **Z1** and Mobile App utilize only a very small fraction of the available bandwidth and throughput. Based on this, the **Z1** and Mobile App are highly tolerant of reductions in wireless quality of service and performance will not be affected until service is essentially lost. Wireless connectivity is not part of the essential performance of the **Z1**. All functions of the **Z1** can be performed on the **Z1** unit itself. The Mobile App and **Z1** are tested for coexistence with other in-band radio frequency sources. The Bluetooth hardware module is FCC listed, and complies with FCC PART 15 SUBPART C.

Technical Specifications

30W Power Adapter

Operating temperature
Operating humidity
Operating altitude
Operating atmospheric pressure
Storage and transport temperature
Storage and transport humidity
Storage and transport altitude
Storage and transport atm. pressure
Electromagnetic compatibility
Aircraft use

IEC 60601-1 classification
Available modes
Deliverable pressure accuracies
Sound pressure level
Nominal dimensions (L x W x H)
Weight
Housing construction
Supplemental oxygen
Standard air filter
Air outlet

Expected Service Life

Performance Specifications

Operating pressure range
Maximum single fault steady pressure
Pressure accuracy

Part # HD60-6010
Unit Input range 100–240V, 50–60Hz
Typical power consumption 20W (30VA)
Maximum power consumption 35W (70VA)
41°F to 95°F (5°C to 35°C)
10–80% Relative Humidity, Non-Condensing
Sea level to 8,000 ft (2,433 m)
101 to 75.3 kPA
-4°F to +140°F (-20°C to +60°C)
10–95% Relative Humidity, Non-Condensing
No limit
No limit
Compatible with IEC 60601-1-2
Complies with RTCA DO-160G Standard for use in flight
Class II (double insulation), Type BF
Standby, CPAP and CPAP with ramp
 ± 0.6 cm H₂O $\pm 4\%$ of the measured reading
26 dBA
6.48" X 3.30" X 2.02" (16.46 cm x 8.38 cm x 5.13 cm)
10 oz. (238 g)
Flame retardant engineered thermoplastic
Not for use with oxygen
Polyester
The 22 mm air outlet complies with ISO 5356-1
Battery charges when Z1 not in use.
Z1, PowerShell and Power Supply: 5 years
Tube Adaptor, USB Cable and End Cap: 2 years
Filter, CPAP TUBE: See Care Instructions.

4 to 20 cm H₂O
30 cm H₂O
 $\pm(0.6$ cm H₂O + 4% of the measured reading)

PowerShell Battery Specifications











Longevity (typical operating time)*

Z Breathe Setting	14 cmH ₂ O	20 cmH ₂ O
1	8.4 hr	> 4.9 hr
2	8.5 hr	> 4.9 hr
3	7.5 hr	4.9 hr

* Results reflected were obtained via bench testing under simulated operating conditions. Individual results may vary.

Capacity	45 Watt-hours
Lifetime	approximately 300 charge/discharge cycles
Shelf life	Batteries are shipped with between 30% and 50% of rated capacity, providing a minimum of 6 months shelf life when stored at 25°C. If storage temperature exceeds 25°C over a 6-month period then shelf life will be reduced and the battery should be recharged periodically.
Storage and transport temperature	-4°F to +140°F (-20°C to +60°C)
Storage and transport humidity	≤80% Relative Humidity, Non-Condensing
Battery Technology	Lithium Ion Battery Pack, 4S1P
Weight	Approx. 8 oz. (227g).
Charging	Battery charges when Z1 is in standby mode.

The following symbols may appear on your device, power supply unit, or packaging.

-  Refer to Manual
-  type BF equipment;
-  Class II equipment;
-  Start/stop;
- IP22** Ingress Protection (IP) Rating;  Manufacturer;
-  **LOT** Batch code;  **REF** Catalog number;
-  **SN** Serial number;  Direct current;
-  Product disposal warning to EN50419; .
-  Disengagement Mechanism; **RX ONLY** Prescription only (In US. Federal law restricts these device to sale by or on order of a physician)

Servicing

The **Z1 System** is intended to provide safe and reliable operation when operated in accordance with the instructions provided by Human Design Medical. Human Design Medical recommends that the **Z1 System** be inspected and serviced by an authorized Human Design Medical Service Center if there is any sign of wear or concern with **Z1** function. Otherwise, service of the **Z1** generally should not be required during the warranty period (see 'Limited Warranty' for details) of the device.

Limited Warranty

Human Design Medical warrants that your Human Design Medical product shall be free from defects in material and workmanship from the date of purchase for the period specified below.

Component	Warranty Period
Z1 Auto device	3 years
PowerShell	2 years
Overnight Battery	9 months
Power Supply	2 years

If product fails to perform in accordance with product specifications, Human Design Medical will repair or replace, at its option, the defective material or part. This warranty is only available to the initial purchaser. It is not transferable. If the product fails under conditions of normal use, Human Design Medical will repair or replace, at its option, the defective product or any of its components. This limited warranty does not cover: a) any damage caused as a result of accident, improper use, abuse, modification or alteration of the product; b) repairs carried out by any service organization that has not been expressly authorized by Human Design Medical to perform such repairs; c) any damage or contamination due to cigarette, pipe, cigar or other smoke; d) damage caused by water entering the product. Warranty claims on defective product must be made by the initial purchaser by calling Human Device Medical service support at 1-855-436-8729.

THIS WARRANTY REPLACES ALL OTHER EXPRESSED OR IMPLIED WARRANTIES, INCLUDING ANY IMPLIED WARRANTY OF MERCHANTABILITY OR FITNESS FOR A PARTICULAR PURPOSE. SOME REGIONS OR STATES DO NOT ALLOW LIMITATIONS ON HOW LONG AN IMPLIED WARRANTY LASTS, SO THE ABOVE LIMITATION MAY NOT APPLY TO YOU.

HUMAN DESIGN MEDICAL SHALL NOT BE RESPONSIBLE FOR ANY INCIDENTAL OR CONSEQUENTIAL DAMAGES CLAIMED TO HAVE RESULTED FROM THE SALE, INSTALLATION OR USE OF ANY HUMAN DESIGN MEDICAL PRODUCT. SOME REGIONS OR STATES DO NOT ALLOW THE EXCLUSION OR LIMITATION OF INCIDENTAL OR CONSEQUENTIAL DAMAGES, SO THE ABOVE LIMITATION MAY NOT APPLY TO YOU.

This warranty gives you specific legal rights, and you may also have other rights which vary from region to region. For further information on your warranty rights, contact your local Human Design Medical dealer or Human Design Medical office at 1-855-436-8729.

Contact Information

Human Design Medical, LLC
200 Garrett Street, Suite P
Charlottesville, VA 22902
www.hdmusa.com

Main phone (Supplies & replacement parts):
Service support or warranty coverage:
Email:
General:



1-855-436-8724 [1-855-HDMUSA4]
1-855-436-8729 [1-855-HDMUSA9]
service.support@hdmusa.com
info@hdmusa.com



If you are planning on using your Z1 on an airplane, please detach this letter and carry it with you.

FAA Compliance

To whom it may concern:

The US Department of Transportation (DOT) Final Rule, “Nondiscrimination on the Basis of Disability in Air Travel” (73 FR 27614 which updates Title 14 CFR Part 382), effective May 13, 2009 provides important requirements for the accomodation of passengers with respiratory assistive devices (Ventilators, Respirators and CPAP machines).

In line with these requirements, respiratory assistive devices may be used onboard an aircraft, without further testing by the carrier, provided they have been tested for Electromagnetic Compatibility (EMC) in accordance with the current version of RTCA/DO-160, Section 21, Category M.

Human Design Medical has successfully completed testing for the Z1 Auto System. The Z1 Auto System complies with RTCA/DO-160, Section 21, Category M and can be considered FAA compliant.*

Some airlines may require advance notification before travel, and devices may need to be operated by battery. Human Design Medical recommends that customers check with their airline.

* Z1 Bluetooth must be in the off (airplane mode) position similar to any other mobile device to maintain compliance

This page is intentionally left blank.



Mail completed form to:
HDM Product Registration
200 Garrett St, Suite P
Charlottesville, VA 22902

Register your new device.

Registering your device allows us to provide better customer service and warranty coverage. Please register as soon as possible.

About you.

NAME:

First

MI

Last

EMAIL ADDRESS:

MAILING ADDRESS:

Street or PO Box

City

State

Zip

PHONE NUMBER:

About the device.

WHAT DEVICE DID YOU PURCHASE?

WHERE DID YOU PURCHASE THE DEVICE?

PURCHASE DATE:

[MM/DD/YY]

Z1 SERIAL NUMBER

POWERSHELL SERIAL NUMBER

The device serial number can be found on the back of the unit. Look for the string of numbers following **SN**

This page is intentionally left blank.



Human Design Medical, LLC
Charlottesville, VA 22902