



Micro™

User Manual



Table of Contents

Introduction.....	4
Indications for Use.....	4
Contraindications.....	4
Adverse Effects.....	4
Transcend Micro Components	5
Your Transcend Micro	6
Setting Up Your Transcend Micro.....	6
<i>AirFlex™ air hose connection</i>	6
<i>Power supply: AC adapter</i>	7
<i>Power supply: PowerAway battery</i>	8
Connecting Comfort Features.....	9
<i>WhisperSoft™ muffler assembly</i>	9
<i>AirMist™ HME adapter assembly</i>	9
Navigating the Device Buttons.....	10
<i>Control panel</i>	10
<i>Power button and LED indicators</i>	10
<i>Bluetooth button and LED indicators</i>	10
<i>Ramp button and LED indicators</i>	11
<i>Dry cycle button and LED indicators</i>	11
Using MySleepDash app	12
<i>Connecting your smart device to the app</i>	12
<i>Connecting your Transcend Micro to the app</i>	12
Starting Therapy.....	13
Using the Ramp Function	13
Using the AirRelief (EZEX) Function	13
Ending Therapy	14
Drying Mode.....	14
Caring for your Device	14
Disconnecting Comfort Features	15
<i>WhisperSoft muffler assembly</i>	15
<i>AirMist HME adapter assembly</i>	15
Cleaning the Exterior	15
Cleaning of Accessories	16
<i>Transcend batteries</i>	17
<i>Replacing the Transcend Micro PureFresh™ air filter</i>	17
Cleaning for Multiple Users.....	17
Environmental Information	18
Traveling with Your Transcend Micro.....	18
Troubleshooting	19
Precautions for Use.....	21
Warnings.....	21
Cautions	22
Symbols	24
Technical Specifications.....	25
AC Power Supply PSA 5 (laptop style).....	25

AC Power Supply PSA 4 (wall mount style)	25
Battery (optional).....	25
Transcend Micro Performance	25
Software Functionality and Device Data	26
<i>Software license</i>	26
<i>Use of device data</i>	26
Electromagnetic Compatibility.....	27
<i>Electromagnetic Emissions</i>	27
<i>Electromagnetic Immunity</i>	28
IEC 60601-1 (Third Edition) Classification.....	30
Performance	30
<i>Pressure</i>	30
<i>Sound</i>	31
Appendix.....	32
<i>Part Numbers: Disposables</i>	32
<i>Part Numbers: Accessories</i>	32
<i>Part Numbers: Replacements</i>	32
<i>Limited Warranty</i>	33
Notices	35
Contact Transcend Inc.	35

Introduction

The Transcend® Micro™ is Transcend's smallest and lightest Continuous Positive Airway Pressure (CPAP) device.



Federal law in the US restricts this device to the sale by, or on the order of, a physician.

Indications for Use

The Transcend Micro provides positive airway pressure for treatment of obstructive sleep apnea (OSA) in adults weighing over 66 pounds (30 kg). The device is intended for home and hospital/institutional use.

Contraindications

The Transcend Micro may be contraindicated in patients with the following conditions:

- Bullous lung disease
- Pathologically low blood pressure, particularly if associated with intravascular volume depletion
- Pneumothorax or pneumomediastinum
- Pneumocephalus has been reported in some users using nasal PAP.

Caution should be used when prescribing PAP for susceptible users such as those with any of these conditions:

- Cerebral spinal fluid (CSF) leaks
- Abnormalities of the cribriform plate
- A prior history of head trauma
- Pneumocephalus

Adverse Effects

You should report unusual chest pain, severe headache, or increased breathlessness to your prescribing physician. An acute upper respiratory tract infection may require temporary discontinuation of treatment.

The following side effects have been reported by users of airway delivery devices during CPAP therapy.

- Congestion or mucus in the throat
- Sneezing or cough

- Bloating
- Nocturnal waking
- Feelings of claustrophobia
- Burn
- Irritation/dryness of the mouth, nose, or throat
- Nosebleed
- Skin rashes
- Eye irritation
- Ear or sinus discomfort

Transcend Micro Components

The Transcend Micro system includes the following:





- Transcend Micro
- Transcend AirFlex™ 6 (6-foot Air Hose)
- Transcend WhisperSoft™ Micro Muffler
- 5-inch Air Hose
- Transcend Micro Quick Guide
- Transcend Travel Pouch
- Power supply: 40W AC

Contact your CPAP supplier for a range of accessories available separately for use with the device, including:

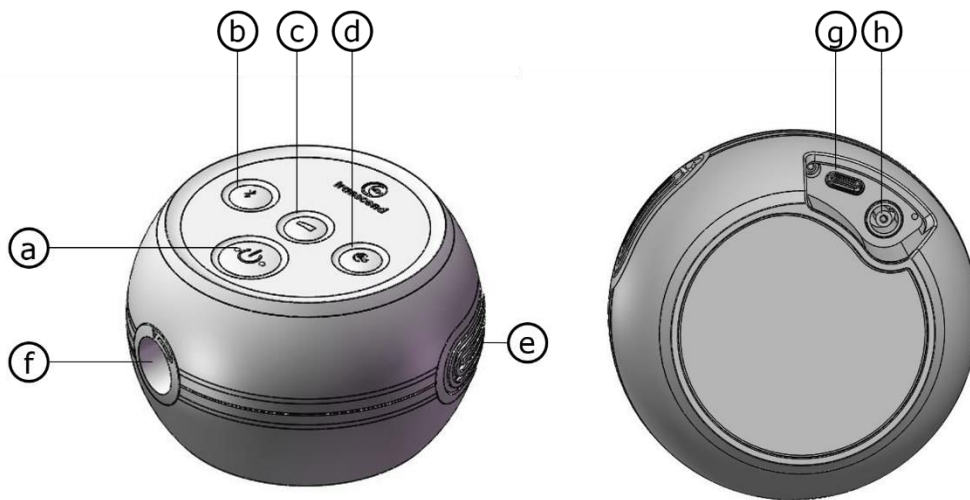
- Transcend AirFlex™ Micro 6 (6-foot Air Hose)
- Transcend AirFlex™ Micro 4 (4-foot Air Hose)
- Transcend AirFlex™ 4 (4-foot Air Hose)
- Transcend AirMist™ HME Kit (1 HME Adaptor, 4 Cartridges)
- Transcend AirMist™ Starter Pack (1 HME Adaptor, 2 Cartridges)
- Transcend PowerAway™ P8 Battery
- Transcend Portable Solar Battery Charger
- Transcend SleepPak™ Travel Bag
- Patient CPAP Mask

Your Transcend Micro



- a. Power button 
- b. Bluetooth button 
- c. Pressure ramp button 
- d. Dry cycle button 
- e. Air filter cover
- f. Air outlet
- g. USB-C data port
- h. Power supply inlet

Setting Up Your Transcend Micro

AirFlex™ air hose connection

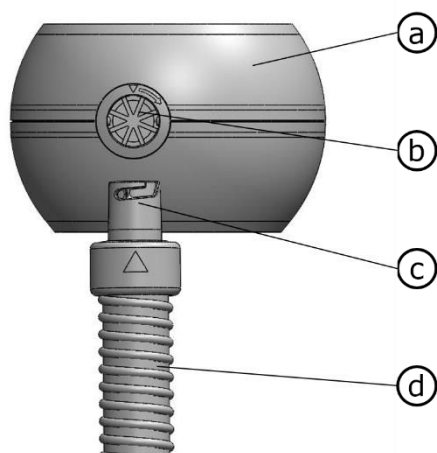

- a. Transcend Micro device
- b. Air outlet
- c. Air hose coupler
- d. AirFlex hose

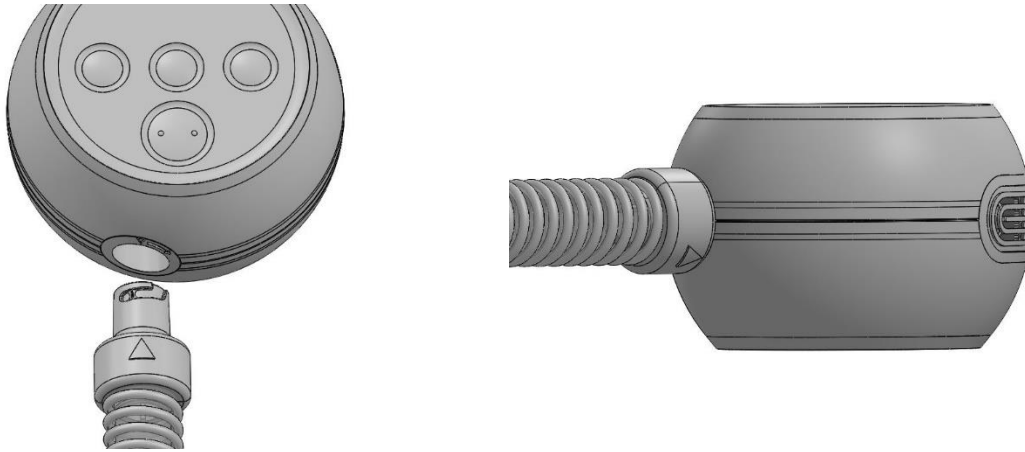

1. Connect the hose firmly to the air outlet on the device by inserting the hose coupler into the air outlet on the device.
2. Locate the arrow on the air hose coupler and arrow on the device.
3. Align the arrows and gently insert at a slight angle and twist the air hose coupler clockwise until you feel it begin to insert. Continue twisting until the air hose connector is seated securely into the device. The image below indicates a fully secured hose with the hose arrow below the parting line of the device.
4. Connect the Transcend WhisperSoft muffler to the opposite end of the air hose.
 - **If not using the Transcend WhisperSoft muffler:** connect the air hose coupler of a Transcend AirFlex™ Micro air hose into the device air flow outlet. Then connect the opposite end of air hose to the mask.
 - To remove the hose simply turn it counterclockwise and pull gently away from the device

NOTE: The hose is the applied part and constitutes the air pathway.

Power supply: AC adapter

Follow steps for the appropriate power supply model included with the Transcend Micro system.

When connected to power, each LED will flash. When flash sequence is completed, the green Power LED light and Bluetooth LED will remain on.

For PSA5 Power Supply:

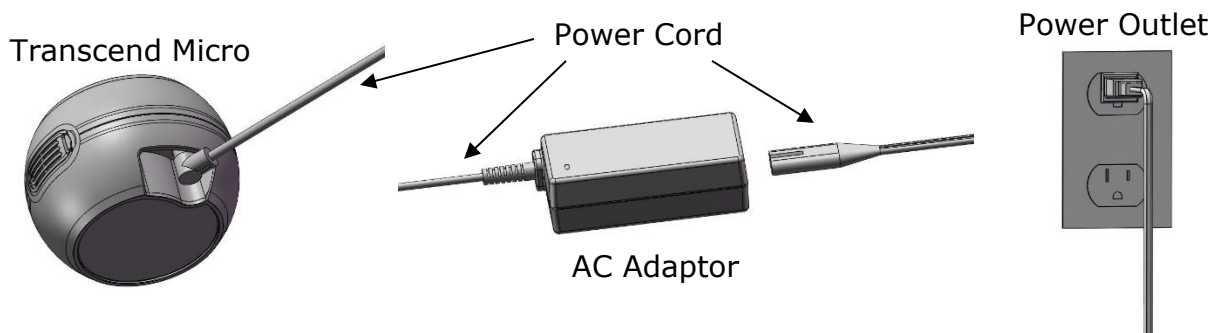

1. Connect the power cord from AC adapter into the power outlet at the bottom of the device.
2. Connect one end of the power cord into the AC adaptor and the other end into the power outlet.

For PSA4 Power Supply:

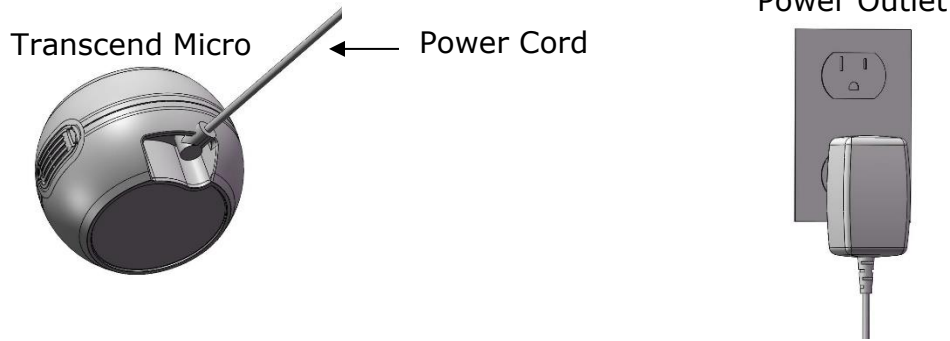

1. Connect the power cord from AC adapter into the power outlet at the bottom of the device.
2. Connect power cord from device power inlet directly to power outlet.

NOTE: Ensure the power cord is accessible so that it can be easily unplugged from the wall.

Power supply: PowerAway battery

To use the Transcend PowerAway battery as the primary power supply.

1. Fully charge the Transcend PowerAway battery before the first use by connecting it to the AC adapter and a power outlet. The battery will begin to charge automatically.

NOTE: Do not connect the battery to the Transcend Micro during the initial charge.

2. Once the battery is fully charged, it is ready for use with the Transcend Micro. It may take up to eight (8) hours to charge the PowerAway battery.

To use the Transcend PowerAway battery in conjunction with AC line power as a backup power supply to provide uninterrupted therapy in the case of a power outage.

1. Insert the barrel connector of the battery into the Transcend Micro power jack.
2. Insert the barrel connector from the AC adapter into the Transcend PowerAway battery.
3. Connect one end of the power cord into the AC adapter and the other end into the power outlet.
4. When connected to power, each LED will flash once. When completed, the green Power LED light will remain on.

See the Transcend PowerAway Battery User Guide on myTranscend.com for guidance information on setup, use and caring for Transcend batteries.

Connecting Comfort Features

WhisperSoft™ muffler assembly

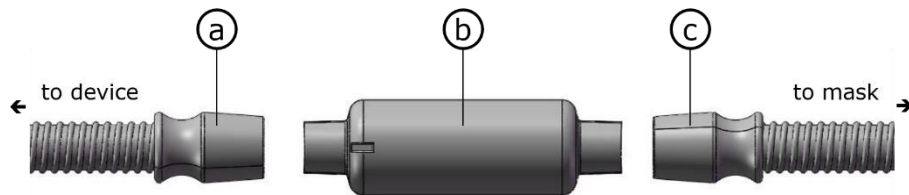

- a. Short air hose
- b. WhisperSoft muffler
- c. Long air hose

1. Attach the short muffler air hose to the device.
2. Attach the short muffler air hose to the WhisperSoft muffler.
3. Attach one end of long (mask) air hose to the other end of the muffler and then attach the opposite end to the mask or HME (Heat/Moisture Exchanger).

AirMist™ HME adapter assembly

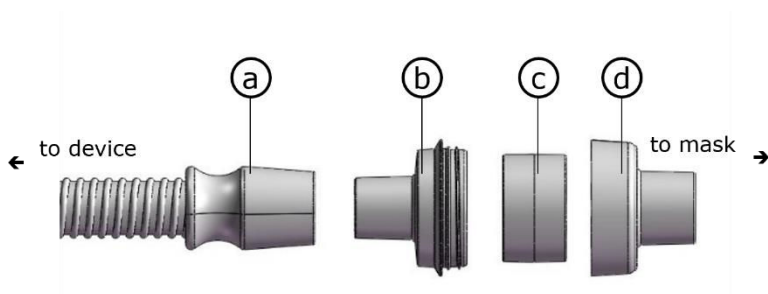

- a. Air hose
- b. HME adapter bottom
- c. HME cartridge
- d. HME adapter top

The Transcend AirMist HME assembly is sold separately and is an add-on accessory that is not included with the Transcend Micro system.

1. Remove the HME cartridge from foil package. Handle by the plastic shroud not the foam core.
2. Unscrew the HME adapter bottom from the HME adapter top and place the HME cartridge inside the HME adapter bottom.
3. Place the HME adapter top onto the HME adapter bottom and gently turn the top until the adapter compresses together on the HME cartridge.

Securely attach the HME adapter bottom to your hose.

4. Securely attach the HME adapter top to your mask.

Navigating the Device Buttons

Control panel

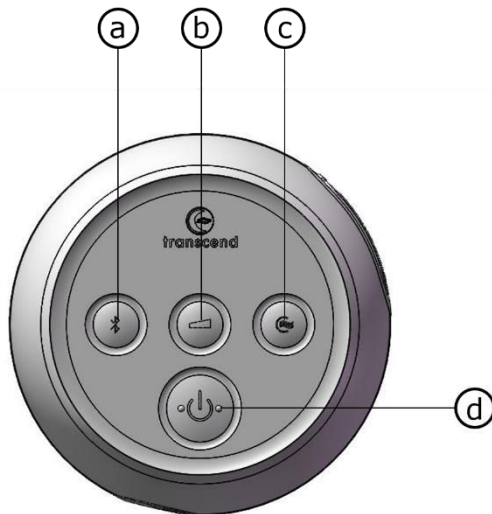

- a. Bluetooth
- b. Pressure ramp
- c. Dry cycle
- d. Power

Power button and LED indicators

Standby Mode

When the device is plugged in, it will be in Standby Mode.

- The LED glows green, indicating that the device has power.
- Pressing the power button transitions the device to Therapy Mode.
 - All LEDs will turn off.
 - The blower will start and the device will begin regulating pressure.

Therapy Mode

When the device is powered and in Therapy Mode:

- The LED is off.
- Pressing the power button transitions the device to Standby Mode.
 - The LED glows green.
 - The blower stops.

Bluetooth button and LED indicators

Standby Mode

Pressing the Bluetooth button toggles communication between enabled/disabled.

Bluetooth indicator light is blue	Bluetooth communication is enabled but there is not an active connection with a mobile device.
Bluetooth indicator light is green	Bluetooth communication is enabled and there is an active connection with a mobile device.

Bluetooth indicator light is white	Bluetooth communication is disabled.
------------------------------------	--------------------------------------

Therapy Mode

Pressing the Bluetooth button has no effect while in Therapy Mode.

Bluetooth indicator light is off	Therapy Mode is on.
----------------------------------	---------------------

Ramp button and LED indicators

Standby Mode

- The LED glows blue if the Ramp is configured and auto-ramp is enabled.
 1. If therapy is started when the ramp LED is on, the device will begin at a lower, ramp pressure. The device will arrive with Ramp enabled.
- The LED is off if Ramp is not configured, or Auto Ramp is disabled.
 1. If therapy is started when the ramp LED is off, the device will begin at the starting therapy pressure.
- Pressing the button when Ramp is not configured has no effect.
 1. See Transcend desktop software user guide to configure <https://mytranscend.com/customer-care/user-guides/>
- Pressing the button when Ramp is configured toggles Auto Ramp between enabled and disabled.

Therapy Mode

- The LED is off.
- If Ramp is active, pressing and holding the button accelerates Ramp increase.
- If Ramp is configured but not active, pressing the button starts Ramp.
- If Ramp is not configured, pressing the button has no effect.

Dry cycle button and LED indicators

Standby Mode

- The LED is off when Drying Mode is off.
- The LED glows blue when Dry Cycle is on.
- Pressing the Dry Cycle button toggles between on and off.

Therapy Mode

- The LED is off.
- Pressing the button has no effect.

Using MySleepDash app

Transcend MySleepDash is a smart device app that will guide you through the setup process of your new Transcend Micro device. It includes setup videos, helpful information, and can track your sleep health progress. The app is not required in order to operate the Transcend Micro device.

Before connecting Transcend Micro to a smart device, ensure that the latest version of the MySleepDash app is installed on the smart device. The app is available for download from the App Store or Google Play.

Connecting your smart device to the app

- Ensure your Transcend Micro device is set up correctly and plugged into a power source.
- On your smart device, enable Bluetooth.
- Open the MySleepDash app.
- The first time you open the MySleepDash app, you will be asked to login or create an account using your email. You will be required to:
 1. Provide consent for the use of analytics.
 2. Accept Transcend's terms of use and privacy notice.
 3. Provide consent for the MySleepDash app to upload data to the cloud.

Additional information about terms and privacy policies are provided on the Create Account page.

- Once selections are complete on the Create Account page, tap submit.

After creating your account, you will be required to login using the email and password you just set up.

- The next step will be to connect your Transcend Micro device to the MySleepDash app.

Connecting your Transcend Micro to the app

- Ensure Bluetooth is enabled on the Transcend Micro device. The Bluetooth LED will glow blue to indicate that Bluetooth is enabled.
 - If the Bluetooth LED is glowing white, press the Bluetooth button to enable Bluetooth.
 - If the Bluetooth LED is off, verify that the device is powered and in standby mode.
- On the MySleepDash app, tap continue the welcome page.
- Tap the QR code icon to open your camera. You may be required to allow the device to use the camera features.
- Locate the QR code on the bottom of the Transcend Micro device and scan using the camera on your smart device.
- Click add to complete adding your device.

- The blue LED light on the Transcend Micro will turn green.
- Your device is now connected, follow the on-screen prompts on your smart device to continue setup.

Starting Therapy

1. Connect the Transcend Micro to a power source and allow it to enter Standby Mode.
2. Be sure your mask fits firmly and in place before starting therapy.
3. Press the Power button or breathe normally to engage SleepStart. Therapy will begin when the blower delivers or ramps to the prescribed therapy pressure.

NOTE: Some masks are configured differently. Due to this variability SleepStart may not function.

NOTE: If therapy is interrupted by a power failure, the device will automatically restart therapy once power is restored.

Using the GentleRise Ramp Function

The Ramp feature lets you acclimate to air flow by starting at a lower pressure and gradually increasing to the prescribed pressure setting as you fall asleep.

To accelerate the rate of the pressure increase during Ramp mode:

- Hold the Ramp button down until the device reaches a comfortable therapy pressure.
- When the Ramp button is released, the device will continue in Ramp Mode until it reaches the prescribed therapy pressure.
- To end Ramp early, hold down the Ramp button until the prescribed therapy pressure is reached.
- If Ramp is no longer desired, disable it via software. Or disable auto-ramp by pressing the Ramp button when in standby.

NOTE: Once installed and connected you may use the MySleepDash app to change ramp settings on compatible Micro devices. Alternatively, to adjust ramp starting pressure or duration see the Transcend Micro software manual available on the Transcend website (mytranscend.com).

Using the AirRelief (EZEX) Function

The AirRelief (EZEX) function is a feature that decreases therapy pressure on exhalation. This is designed to provide additional comfort to the user by reducing the amount of resistance they experience as they exhale.

There are four settings: OFF, 1, 2 or 3. Each setting progressively increases the amount of pressure relief from none to maximum.

Once installed and connected you may use the MySleepDash app to change Air Relief settings on compatible Micro devices. Alternatively, see the Transcend Micro software manual available on the Transcend website (mytranscend.com) and follow the steps to change settings.

Ending Therapy

Remove your mask and press the power button to end therapy.

Drying Mode

At the end of each therapy session, it is recommended that the user initiate the Drying Mode function to dry the attached air hose and accessories.

To initiate Drying Mode:

- Press the Drying Mode button.
- When in Drying Mode, the blower will run at a low speed for 30 minutes.
- During Drying Mode, the Drying Mode LED will continue to glow.
- After 30 minutes, the blower will turn off and the device will enter Standby Mode.

Caring for your Device

Warning Unplug the Transcend Micro device before cleaning and make sure it is dry before plugging it in again. Do not perform any cleaning or maintenance tasks while the device is in operation. Damage caused by improperly caring for your device may not be covered by Transcend's limited warranty.

- Do not submerge the Transcend Micro device, power supply or power cord in water.
- Prevent water from entering any openings of the device.
- Do not use harsh or abrasive cleaning agents to clean the device or any components.
- Do not attempt to sterilize the Transcend Micro device.
- Do not place cleaning materials, such as a cloth or liquid, into the device air inlet or air outlet connector.
- Do not open or modify the device. There are no user-serviceable parts inside the device. Servicing and repairs should only be performed by an authorized Transcend person.
- Do not use chlorine, bleach, or scented cleaning solutions, antibacterial or moisturizing soaps or oils, including scented oils, to clean the device or its components. These solutions may damage the device or reduce its life.
- Exposure to smoke, including cigarette, cigar or pipe smoke may damage the device.
- Exposure to ozone or other gases may damage the device..

Disconnecting Comfort Features

WhisperSoft muffler assembly

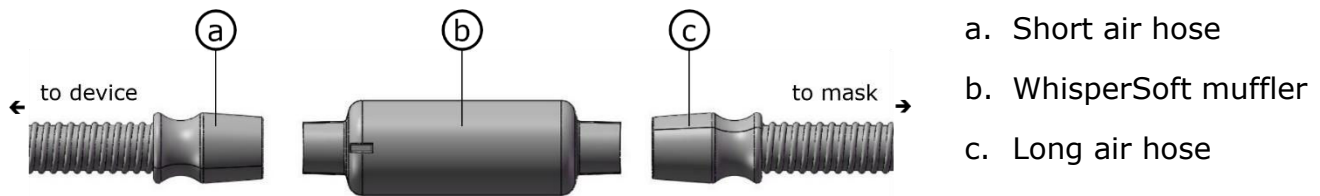

1. Remove the short air hose from the device, by twisting the connector left or counterclockwise and pulling the hose away from the device. Disconnect the other end of the hose from the muffler.
2. Remove the muffler from one end of your long hose and your mask from the other end of the hose.
3. After following the cleaning process, refer to steps in the Connecting Comfort Feature section to reassemble the muffler.

AirMist HME adapter assembly

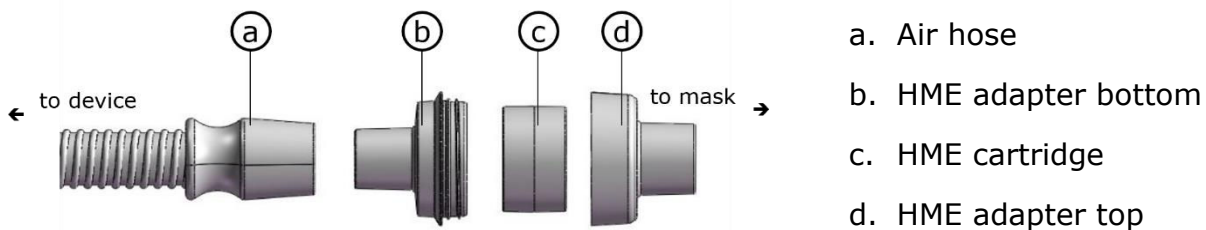

1. Remove the HME assembly from your mask
2. Remove the HME assembly from your hose
3. Unscrew the HME adapter bottom from the HME adapter top.
4. Discard the HME cartridge. The HME cartridge plastic and foam are not to be cleaned and should only be replaced.
5. After following cleaning process, refer to steps in the Connecting Comfort Feature section to reassemble the HME adapter.

Cleaning the Exterior

Follow these instructions to clean the exterior of the Transcend Micro device.

1. Mix a solution of 5% mild liquid detergent in distilled water (1.6 fl. Oz. liquid detergent per quart of distilled water). Mild detergent should contain biodegradable anionic surfactants and no phosphate.
2. Submerge a lint-free cotton cloth into the detergent solution.

3. Wring excess water from the cloth then wipe the exterior surface of the Transcend Micro device for approximately 20 seconds using a gentle back and forth wiping motion. Ensure contact with all accessible surfaces to adequately remove any soil buildup.
4. Rinse the cloth in clear water to remove residual cleaning solution.
5. Wring excess water from the cloth and wipe the Transcend Micro using a gentle front to back wiping motion to remove any detergent solution remaining on the surface.
6. Wipe the device with a dry, lint-free cotton cloth until the device is fully dry.

Cleaning of Accessories

The following accessories should be cleaned with a 5% solution of mild dishwashing liquid detergent in distilled water (1.6 fl. oz. liquid cleaning detergent per quart of distilled water). Mild detergent should contain biodegradable anionic surfactants and no phosphate.

Clean the device and its components as shown in the schedules below in order to maintain the quality of your device and to help prevent the growth of germs that can adversely impact your health.

Accessory	Periodic Cleaning Cycle	Product Service Life
AirFlex Hose	Weekly	3 Months
WhisperSoft Muffler	Weekly	3 Months
AirMist HME	Weekly	3 Months

Follow these steps to clean the accessories.

1. Fully immerse the accessory in the cleaning solution. DO NOT immerse the Transcend Micro device.

NOTE: HME Cartridge must be removed prior to cleaning the HME Adapter. The HME cartridge cannot be cleaned; discard after 3-7 days of use.
2. While immersed, thoroughly wipe the surface with a lint-free cotton cloth. Apply firm pressure and ensure contact with all accessible connection surfaces to adequately remove soil buildup.
3. Clean the inside of the accessory by lifting then lowering the ends of the accessory, while the accessory is filled with cleaning solution.
4. Rinse accessory by immersing in distilled water. Move the accessory in a back-and-forth motion for approximately 10 seconds to remove cleaning agent residue.
5. Dry the outside of the accessory with a dry, lint-free cotton cloth. Allow the accessory to air dry until the inside is dry. Length of drying time will depend on ambient conditions.

Transcend batteries

- DO NOT immerse batteries in water or cleaning solution.
- For long term storage, which is any duration of time greater than three months, the battery should be:
 - Stored at a temperature above -20C/-4F but below 20C/68F.
 - Stored in a dry location and with an approximate 30% charge. Allow 2 hours to charge battery when fully depleted to achieve 30% charge

See the Transcend PowerAway User Guide on www.mytranscend.com for guidance information on setup, use and caring for Transcend batteries.

Replacing the Transcend Micro PureFresh™ air filter

The Transcend Micro PureFresh air filter should be replaced at a minimum every three months.

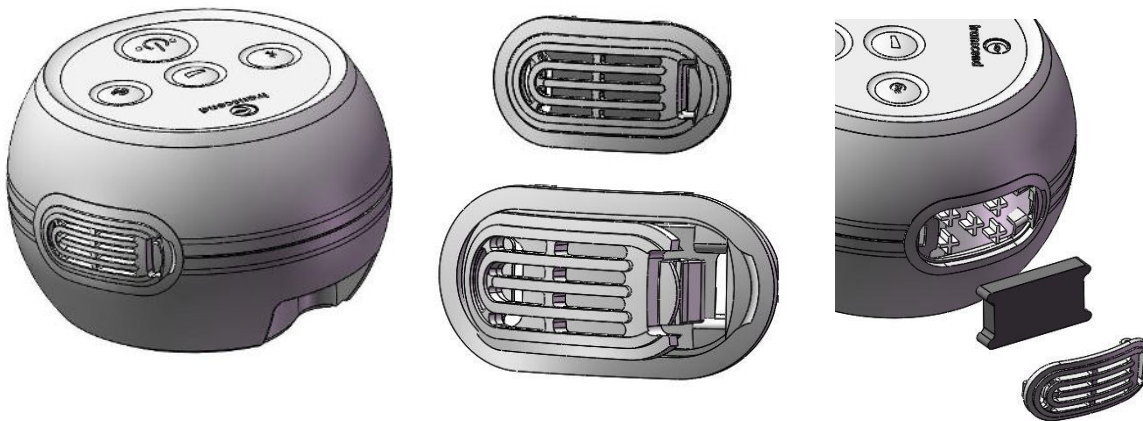

1. Depress the tab on the right side of the filter cover to remove it from the device
2. Remove the filter and discard. Replace with a new filter.
3. Reattach the filter cover by inserting the left side into the device and then clicking the right-side in.

Cleaning for Multiple Users

If using the device on multiple users, perform the following steps to clean the device before each new user:

1. Unplug the power supply prior to cleaning.
2. Remove and discard the bacterial/viral filter.
3. Remove and discard the used air supply tube.
4. Follow instructions for cleaning the exterior of the device as noted in Cleaning the Exterior (above).
5. Apply a new bacterial/viral filter between the hose and the mask before providing the device to a new user.

- Warning** The air supply tubing, mask assembly and bacterial/viral filters should be discarded after each patient use using standard institutional biohazard procedures. No attempt should be made to clean, disinfect, or sterilize these components for multiple users. These components are for single patient use. Manufacturer's instructions must be followed regarding cleaning, disinfecting, and re-use of patient interfaces (masks).
- Warning** Only use bacterial/viral filters that are commercially available and designed for use with CPAP machines. Only use filters that are ISO 23328-1:2003 and ISO 23328-2:2002 approved. Follow the manufacturer's instructions for use of the filter. Only use those commercially available filters that do not require recalibration of the PAP device.
- Warning** Do not submerge the Transcend Micro or power supply in liquid. Do not allow liquid or cleaning solution to enter the device.

Environmental Information

This device should be disposed of separately, not as unsorted municipal waste. To dispose of your device, you should use appropriate collection and recycling systems available in your region. If information on these disposal systems is needed, please contact your local waste administration. If you require information on the collection or disposal of your device please contact Transcend, your homecare provider or go to MyTranscend.com/environment.

California Perchlorate Information:

The coin-cell battery within this device may contain Perchlorate Material - special handling may apply. See: www.dtsc.ca.gov/hazardouswaste/perchlorate

Traveling with Your Transcend Micro

When taking the Transcend Micro device on travels, make sure to have the appropriate power supply for the region you are traveling to. For information on purchasing, contact your care provider.

Traveling by airplane

For some airlines, medical devices do not count toward carry-on luggage limits. Please check with your airline for their policy regarding medical equipment.

You can use your Transcend Micro device on a plane as it meets the Federal Aviation Administration (FAA) requirements. Air travel compliance letters can be downloaded and printed from MyTranscend.com.

When using the machine on an airplane:

- When connected to power, disable Bluetooth (enter airplane mode) by pressing the Bluetooth button until the indicator light is white.
- Do not use the MySleepDash app.
- Use the Start/Stop button on your machine to start therapy.

- To reconnect Bluetooth after exiting the plane, press the Bluetooth button and follow steps to connect to the app.

Troubleshooting

Problem	Possible Cause	Solution
Discomfort due to a feeling of high pressure.	Device pressure may be set too high.	Breathe slowly through your nose with your mouth closed. Use the ramp pressure, if available. If the pressure remains problematic, contact your homecare provider.
Discomfort due to a feeling of low pressure in mask	Device set too low	Contact home care provider for setting change.
	Excessive leaks around hose or mask	Check hose, mask and any accessories in the breathing circuit for air leaks and proper fit.
Dry nose or throat irritation.	Dry air	Add humidity to the room. Replace HME if being utilized. Ensure proper placement of HME. Contact your homecare provider.
	Dirty air path accessory	Follow cleaning instructions for accessories.
	Dirty air filter	Change the air filter.
Device control panel LEDs don't flash or illuminate when the power supply is connected to the device.	Power source is not properly connected.	Check all power connections and verify if the LED light on the power supply is illuminated.
	AC power may not be active.	Use another power outlet. Confirm outlet is not controlled by a wall switch.
No airflow from the device.	Device motor failure; OR electronics failure	Contact the homecare provider's technical service department.
All LEDs flash two times then pause, then flash again	Device detects an operating error	Hold down the power button until all LEDs stops flashing. Release the power button, the device will reset and power up in Standby Mode. Check hose, mask and any accessories in the breathing circuit for air leaks and proper fit. If problems persist, contact your homecare provider

Device shuts down during therapy	Improper seal of external hardware (mask, tubing); or use of external hardware past recommended service life.	Verify all external equipment in breathing circuit is seated correctly to ensure a proper seal. Check hose for leaks. Follow mask manufacturer recommendations for fit and seal.
	Breathing circuit not assembled correctly	Replace any external hardware exceeding recommended service life. If the problem persists, contact your homecare provider.
All LEDs flash four times then pause, then flash again	Device detects an operating error.	Hold down the power button until all LEDs stops flashing. Release the power button, the device will reset and power up in Standby Mode. If the LEDs begin to flash again, contact your homecare provider.
Droplets of water in my mask after therapy	Excess condensation from breathing	Run drying mode after therapy. Utilize in a less humid environment (dehumidifier).
Bluetooth will not connect	Bluetooth disable (White LED light)	Push Bluetooth button to enable (Blue LED light).
	App not downloaded or issue with the app/phone function	Verify app is downloaded and installed, the phone supports Bluetooth Low Energy and has Bluetooth enabled.
Bluetooth will not connect	Bonded pairing information stale	Follow instructions on the phone to forget the Bluetooth connection. On the device, hold down the BT button until the BT LED flashes from blue to yellow once (about 5 seconds).
SleepStart is not functioning	Breathing circuit has excessive leaks	Check hose, mask and any accessories in the breathing circuit for air leaks and proper fit.
	User not breathing deep enough to trigger SleepStart	Ensure deep breath is taken with mask securely fitted or press Power button to start therapy. If the problem persists, call your homecare provider's technical service department.
Bluetooth LED is red (not flashing) all other LEDs are off. Device does not respond to button presses.	Device detects an error during boot-up.	Disconnect power, wait at least 15 seconds, re-connect power. If the problem persists, call your homecare provider's technical service department.

Precautions for Use

This section describes the warnings and cautions associated with use of the Transcend Micro. The following guidelines apply to this document:

- Warning** Indicates the possibility of serious injury or death to yourself or others.
- Caution!** Indicates the possibility of minor injury or damage to the equipment.
- NOTE:** Indicates a tip, explanation, or feature to aid in understanding, or efficient operation of the device.

Warnings

- Do not allow water to enter this device. Transcend Micro should not be exposed to environmental conditions where the system may get wet.
- This device is not intended for life support.
- The Transcend Micro must be set up and adjusted by a trained provider before being used for therapy ramp and pressure.
- The air temperature produced by this device can be as much as 10°F higher than the temperature of the room. Exercise caution if the room temperature is warmer than 90°F (32°C).
- Do not block or otherwise obstruct the exhalation ports of the mask. Follow the manufacturer's instructions included with your mask.
- This equipment is not suitable for use with oxygen or in the presence of a flammable anesthetic mixture with air or oxygen, or with nitrous oxide. Sources of oxygen must be located more than 1 meter from the equipment to avoid the risk of fire and burns.
- The Transcend Micro is only to be used with the supplied or recommended accessories. Use of accessories not recommended may result in increased electromagnetic emissions or decreased electromagnetic immunity of the PAP system and may be potentially unsafe.
- The Transcend Micro is not defibrillation proof.
- Do not attempt to sterilize Transcend Micro.
- If the device is to be used by multiple patients a main flow bacteria filter should be installed in-line between the device and the mask to prevent contamination. Only use filters that are ISO 23328-1:2003 and ISO 23328-2:2002 approved.
- The device should be used only with masks and connectors recommended by Transcend or a health care professional. A mask should not be used unless the device is turned on and is properly delivering ramp or therapy pressure. The exhalation port(s) associated with the mask should never be blocked. Explanation of the Warning: The device is intended to be used with masks or connectors specifically designed to have exhalation ports to allow continuous flow of air out of the mask. When the device is in operation, air flow from the device flushes exhaled

air out through the mask exhalation port. When the device is not operating, however, fresh air will not be provided through the mask and exhaled air may be rebreathed.





















- Failure to use a mask or accessory that minimizes rebreathing of carbon dioxide or permits spontaneous breathing can cause asphyxiation. Only use masks which comply with ISO 17510.
- Do not position the equipment in bed. Covering breathing tubes with a blanket or heating them can affect the quality of therapy or injure the user.
- To prevent disconnection of the tubing during use only Transcend supplied hoses or hoses in compliance with ISO 5367 or ISO 80601-2-74 should be used.
- Strangulation hazard from power cord and air tube. These can become wrapped around a neck and STRANGLE. Keep power cord and air tube more than 3 feet from a baby's crib and out of baby's reach. Keep cord and tube out of children's reach.
- Small parts are unlikely to be expelled from the Transcend Micro enclosure, but in case of severe damage internal components may fragment and create a swallowing or choking hazard if they get out of the enclosure.
- Use of this equipment adjacent to or stacked with other equipment should be avoided because it could result in improper operation. If such use is necessary, this equipment and the other equipment should be observed to verify that they are operating normally.
- Use of accessories, transducers and cables other than those specified or provided by the manufacturer of this equipment could result in increased electromagnetic emissions or decreased electromagnetic immunity of this equipment and result in improper operation.
- Portable RF communications equipment (including peripherals such as antenna cables and external antennas) should be used no closer than 30 cm (12 inches) to any part of the Micro device.

Cautions

- Federal law in the US restricts this device to the sale by, or on the order of, a physician.
- Power the Transcend Micro only with the Transcend-supplied power supplies or batteries.
- Discontinue use of the Transcend Micro and contact your physician if respiratory or skin irritations occur.
- Do not introduce objects into the Transcend Micro air inlet or air outlet.
- Inspect the power supply for signs of wear or damage before each use. Replace the power cord if necessary.
- Transcend recommends replacing the hose after every three months of use.
- To protect the environment, some parts and accessories of the Transcend Micro, including optional batteries, must be disposed of in accordance with local regulations.

- The user should not touch the USB-C data port or the power supply connectors at the same time while the device is providing therapy.
- The equipment must not be covered or positioned in such a way that adversely affects the performance of the equipment, as it may also create a safety issue. Examples of this would include:
 - The equipment must not be positioned in a bed.
 - The equipment should not be placed anywhere other than on a firm, flat surface.
 - Do not position in a location where pets or children can access equipment.
 - Do not position near an open window or other location where dust, or pests (insects) can affect equipment safety and/or performance.
 - Do not position next to a curtain that blocks the flow of cooling air, thereby causing the equipment to overheat.
 - Do not block the air intake port, thereby interfering with therapy.

Symbols

	Ramp functionality
	Drying Mode
	Power
	Caution
IP22	Protected against finger-sized objects and against dripping water when tilted 15 degrees from specified orientation
	Type BF Applied Part
	Upper and lower temperature limits
	Separate collection for electrical and electronic equipment per EC Directive 2002/96/EC. – Waste Electrical and Electronic Equipment (WEEE).
	Consult instructions for use
Rx Only	Prescription only. U.S. federal law restricts this device to sale by or on the order of a physician or properly licensed practitioner.
	Precedes reference or item number
	Batch code
	Date of Manufacture
	Manufacturer
	Fragile, handle with care
	Keep dry
	Serial Number
	Bluetooth
	Regulatory Compliance Mark – indicates compliance with Australian Radiocommunications Notice 2014 and Radiocommunications Act 1992
	Wireless. FCC part 15 compliant. RTCA/DO-160 Section 21 Category M compliant & FAA compliant.
	Shipping and storage temperature limitation.
	Shipping and storage relative humidity limitation.
	UL Seal of Approval demonstrating quality, safety and professional manufacturing of medical product.

Technical Specifications

Transcend Micro weight:	0.48 lbs (219.5g)
Transcend Micro dimensions:	3.6 in x 3.6" x 2.4" (9.1 cm x 9.1 cm x 6.1 cm)
Air outlet connector port dimensions:	Custom interface to device, standard 22-mm diameter connection to user interface
Design life	5 years

AC Power Supply PSA 5 (laptop style)

AC supply input:	100-240 VAC, 50-60Hz, 1.0A Max
AC supply output:	19 VDC 2.1 Amp

AC Power Supply PSA 4 (wall mount style)

AC supply input:	100-240 VAC, 50-60Hz, 1.0A Max
AC supply output:	19 VDC 2.1 Amp

Battery (optional)

Transcend P8 Battery	14.4 VDC, 5,200 mAh
----------------------	---------------------

Transcend Micro Performance

Working pressure range:	4 to 20 cm H ₂ O
Dynamic pressure accuracy for 6' custom hose:	±1 cm H ₂ O or ±10% of set pressure, whichever is greater
Dynamic pressure accuracy for 6' custom hose, muffler, and HME:	±(4% of set pressure + 0.7 cmH ₂ O) (10 BPM) ±(4% of set pressure + 1.0 cmH ₂ O) (15 BPM) ±(4% of set pressure + 1.4 cmH ₂ O) (20 BPM)
Maximum system shutdown pressure:	30 cm H ₂ O
Ramp time duration:	0-45 min + 25%-time variance
Operating temperature range:	41 to 95°F (5 to 35°C)
Storage/transport temperature range:	-4 to 140°F (-20 to 60°C)
Operating humidity range:	10% to 80% relative humidity, non-condensing
Storage/transport humidity range:	10% to 90% relative humidity, non-condensing
Altitude range:	0-8000 feet (Automatically adjusted)

NOTE: Allow one hour for the device to either warm or cool when coming from storage temperature to operating temperature prior to use

Software Functionality and Device Data

The Transcend Micro is a smart device and includes functionalities which allows it to be connected to the MySleepDash app and Transcend Desktop Software so users and their care providers can access therapy data.

Software license

License Grant. Subject to the terms and conditions below, Transcend grants you, the owner and/or user of this device, a perpetual, non-exclusive, non-sublicensable, personal, limited license to use the Transcend Software solely in connection with the use of this device. All other rights are reserved by Transcend. You will be deemed to have transferred and assigned this license to any person that acquires the owner's or the user's rights in this device.

License Restrictions. Software included on or with this device is owned by or licensed to Transcend (the "Transcend Software"). Neither the Transcend Software nor any intellectual property rights in the Transcend Software are sold or assigned by Transcend. No person or entity is licensed or authorized to (a) reproduce, distribute, create derivative works, modify, display, perform, decompile, or attempt to discover the source code for the Transcend Software, (b) remove or attempt to remove the Transcend Software from the Transcend product, or (c) reverse engineer or disassemble the Transcend product or the Transcend Software. For avoidance of doubt, the foregoing restrictions are not intended to limit any licensee's rights to software code incorporated into or distributed with the Transcend Software and licensed under the terms of any open source, free or community software license (collectively, "Open-Source Software").

Use of device data

When you use this device, it gathers and records data about your use and, if your device connectivity is enabled, the device sends certain data to Transcend via the cloud to enable Transcend to deliver various benefits to you and your care provider(s). Additionally, some of that data may be used by Transcend (1) to comply with its legal obligations; these legal obligations include collection and analysis of device data for medical device post market surveillance and vigilance, and compliance with these legal obligations includes assessing if Transcend is required to implement actions to improve device safety, usability and performance, and (2) to perform health-related research, study and/or evaluation for specific scientific and medico-economic purposes. Transcend will only use your device data in compliance with applicable laws and regulations in your country or region (for example the GDPR (Regulation (EU) 2016/679 of the European Parliament and of the Council of 27 April 2016 on the protection of natural persons with regard to the processing of personal data and on the free movement of such data), the MDR (Regulation (EU) 2017/745 of the European Parliament and of the Council of 5 April 2017 on Medical Devices)) in the European Union, and, as applicable, HIPAA (the Health Insurance Portability and Accountability Act of 1996) in the USA). Depending on the data protection or privacy laws of your country or region your device data may constitute your personal data. If so, Transcend has the obligation to inform you about your rights and freedoms regarding our

use of your personal data. You can find more details related to our use of your data, your rights to access, rectify, erase, restrict or object at <https://mytranscend.com/privacy-policy>.

Electromagnetic Compatibility

Transcend Micro complies with all applicable electromagnetic compatibility requirements (EMC) according to IEC60601-1-2:2014 for residential, commercial, and light industry environments. Portable and mobile RF communications equipment should be used no closer to any part of the device, including cables, than the recommended distance of separation (30CM). The Transcend Micro has been designed to meet EMC standards, however, should you suspect the device performance is being affected by other equipment, move the device away from the potential cause of the interference. The Transcend Micro complies with Part 15 of the FCC rules and Industry Canada license-exempt RSS standards. Operation is subject to the following two conditions 1) this device may not cause harmful interference, and 2) this device must accept any interference received, including interference that may cause undesired operation.

Electromagnetic Emissions

The Transcend Micro is intended for use in the electromagnetic environment specified below. The customer or the user of the system should ensure that it is used in such an environment.

Emissions test	Compliance	Electromagnetic environment—guidance
RF radiated emissions CISPR 11	Group 1	The Transcend Micro uses RF energy only for its internal function. Therefore, its RF emissions are very low and are not likely to cause any interference in nearby electronic equipment.
RF conducted emissions CISPR 11	Class B	The Transcend Micro is suitable for use in all establishments, including domestic establishments and those directly connected to the public low-voltage power supply network that supplies buildings used for domestic purposes.
Harmonic distortion IEC 61000-3-2	Class A	
Voltage fluctuations/ flicker emissions IEC 61000-3-3	Complies	

Electromagnetic Immunity

The Transcend Micro is intended for use in the electromagnetic environment specified below. The customer or the user of the system should ensure that it is used in such an environment.	Basic EMC standard	Immunity test levels
Electrostatic discharge (ESD)	IEC 61000-4-2	±2, 4, 8, 15kV air ±8 kV contact
Radiated RF EM fields	IEC 61000-4-3	10 V/m 80 MHz to 2.7 GHz 80% AM at 1 kHz
Electrical fast transient/burst	IEC 61000-4-4	±2 kV 100 kHz repetition frequency
Surges Line-to-ground	IEC 61000-4-5	±1 0, 5 kV ± 1kV
Surges Line-to-ground	IEC 61000-4-5	± 0, 5 kV, ± 1kV, ± 2kV
Voltage dips,	IEC 61000-4-11	0,5 cycle At 0, 45, 90, 135, 180, 225, 270 and 315 degrees 0% Ut; 1 cycle and 70% Ut; 25/30 cycles Single phase: at 0
Voltage interruptions	IEC 61000-4-11	0% Ut; 250/300 cycle

The Transcend Micro is intended for use in the electromagnetic environment specified below. The customer or the user of the system should ensure that it is used in such an environment.	Basic EMC standard	Immunity test levels
Rated power frequency magnetic fields	IEC 61000-4-8	30 A/m 50 Hz or 60Hz
Conducted disturbances induced by RF fields	IEC 61000-4-6	3 V 15 MHz – 80 MHz 6V in ISM and amateur radio bands between 0,15 MHz and 80 MHz 80% AM at 1kHz

Test specifications for enclosure port immunity to RF wireless communications equipment

Test frequency (MHz)	Band (MHz)	Service	Modulation	Maximum power	Distance	Immunity Test Level
385	380-390	TETRA 400	Pulse modulation 18Hz	1, 8	0,3	27
450	430-470	GMRS 460, FRS 460	FM +/-5kHz deviation 1 kHz sine	2	0,3	28
710	704-787	LTE Band 13, 17	Pulse modulation 217 Hz	0,2	0,3	9
745						
780						
810	800-960	GSM 800/900 TETRA 800, iDEN 820, CDMA 850, LTE Band 5	Pulse modulation 18 Hz	2	0,3	28
870						
930						

1720	1700-1990	GSM 1800; CDMA 1900; GSM 1900; DECT; LTE Band 1, 3, 4, 25 UMTS	Pulse modulation 217 Hz	2	0,3	28
1845						
1970						
2450	2400-2570	Bluetooth WLAN, 802.11 b/g/n RFID 2450 LTE Band 7	Pulse modulation 217 Hz	2	0,3	28
5240	5100-5800	WLAN 802.11 a/n	Pulse modulation	0,2	0,3	9
5500						
5785						

IEC 60601-1 (Third Edition) Classification

Class II Type BF IP22. Protected against ingress of solid foreign objects greater than or equal to 12.5 mm in diameter. Vertically falling drops shall have no harmful effects. Equipment not suitable for use in the presence of a flammable anesthetic mixture with air or oxygen, or with nitrous oxide.

Performance

Pressure

Testing in accordance with ISO 80601-2-70:2020 for pressure accuracy and measurement uncertainty of manufacturer's test equipment

Pressure type	Accuracy	Measurement uncertainty
Static at 10 cm H ₂ O	+/- 0.5 cm H ₂ O	Static pressure accuracy has a measurement uncertainty of ±0.16 cmH ₂ O.
Dynamic (with 6' custom hose)	+/- 1.0 cm H ₂ O or 10%, whichever is greater	Dynamic pressure accuracy has a measurement uncertainty of ±0.36 cmH ₂ O.
Dynamic (with 6' custom hose, muffler, and HME)	±(4% of set pressure + 0.7 cmH ₂ O) (10 BPM) ±(4% of set pressure + 1.0 cmH ₂ O) (15 BPM) ±(4% of set pressure + 1.4 cmH ₂ O) (20 BPM)	Dynamic pressure accuracy has a measurement uncertainty of ±0.41 cmH ₂ O.

Maximum flow rate (typical)		Test Pressures				
		4 cm H ₂ O	8 cm H ₂ O	12 cm H ₂ O	16 cm H ₂ O	20 cm H ₂ O
	Measured pressure at the patient connection port (hPa)	2.19	6.28	10.44	14.48	18.62
	Average flow at the patient connection port (l/min)	56.73	55.97	56.41	56.74	55.5

Sound

Values determined according to ISO 80601-2-70:2020 and are reported according to ISO 4871

Sound pressure level (@ 10cm H ₂ O pressure, static)*	27 dBA with an uncertainty of 2 dBA
Sound pressure level (@ 10cm H ₂ O pressure, static)	31 dBA with an uncertainty of 2 dBA
Sound power level (@ 10cm H ₂ O pressure, static)	39 dBA with an uncertainty of 2 dBA

*Sound pressure level reported in a typical use environment

Appendix

Part Numbers: Disposables

Item	Part number	Item	Part number
Transcend AirFlex Micro 6	505004	Transcend AirFlex Micro 4	505027
Transcend AirMist Replacement Cartridges - 4Pack	505014	Transcend AirMist Replacement Cartridges - 8Pack	505015
Transcend AirMist Replacement Cartridges - 12Pack	505016	Transcend Micro PureFresh Air Filters - 2 pk	505017

Part Numbers: Accessories

Item	Part number	Item	Part number
Transcend PowerAway P8 Battery	503023	Transcend Portable Solar Battery Charger	503056
Transcend AirMist Humidification Kit	505009	Transcend AirMist Starter Pack	505030
Transcend WhisperSoft Micro 6	505029	Transcend WhisperSoft Micro 4	505028
Transcend SleepPak	505008		

Part Numbers: Replacements

Item	Part number	Item	Part number
Transcend Micro	505000	Transcend Micro Power Supply (PSA5)	505010
Transcend Micro Filter Cover	505007	Transcend Travel Pouch	505011

For more information on ordering disposable parts, replacement parts or latest accessories please use the QR code provided or go to www.mytranscend.com.



Limited Warranty

Transcend Inc. ("Transcend") provides this non-transferable, limited warranty for the Transcend Micro ("Product") to the initial consumer who purchased the product directly from Transcend or one of its authorized dealers.

Transcend warrants each new Product will be free from defects in materials and workmanship and will perform in accordance with the Product specifications under conditions of normal and proper use and maintenance in accordance with applicable instructions subject to the exclusions below.

This limited warranty lasts two (2) years from the date of purchase by the initial consumer, except that the warranty period for accessories, replacement parts and disposables including, but not limited to, hoses, mufflers, HMEs, carrying case and filters is 90 days from the date of purchase by the initial consumer.

This warranty does not cover (a) any damage caused as a result of improper use, accident, misuse, abuse, water ingress, alteration or modification of the product, (b) repairs carried out by any service organization that has not been expressly authorized by Transcend to perform such repairs, (c) any damage or contamination due to cigarette, pipe cigar or other smoke, (d) any damage caused by exposure to ozone, activated oxygen or other gases (e) failure to operate in accordance with the terms of the operating manual and instructions, (f) lack of reasonable care or (g) other defects not related to material or workmanship. This warranty is not transferable. If Transcend finds that a product returned for service or the issue raised is not covered under this limited warranty, Transcend may charge an evaluation fee and return shipping.

If a Product does not meet the warranty above, Transcend will repair or replace the Product or any of its parts, or refund the original purchase price, at Transcend's sole discretion, subject to the exclusions below. Transcend may use new or remanufactured assemblies, components, and parts in repair and new or refurbished devices for replacement. The balance of the original warranty will apply to any Product or component of a Product repaired or replaced under this warranty.

The warranty is void on any product sold, or resold, outside the country of original purchase.

EXCEPT AS SET FORTH IN THIS LIMITED WARRANTY, TRANSCEND MAKES NO WARRANTIES, EXPRESS OR IMPLIED, STATUTORY OR OTHERWISE REGARDING THE PRODUCT OR ITS QUALITY OR PERFORMANCE. TRANSCEND SPECIFICALLY DISCLAIMS THE IMPLIED WARRANTY OF MERCHANTABILITY AND THE IMPLIED WARRANTY OF FITNESS FOR A PARTICULAR PURPOSE. IN NO EVENT WILL TRANSCEND'S MAXIMUM LIABILITY UNDER THESE WARRANTIES EXCEED THE ORIGINAL PURCHASE PRICE OR WILL TRANSCEND BE LIABLE FOR ANY ECONOMIC LOSS, LOSS OF PROFITS, OVERHEAD OR SPECIAL, INCIDENTAL OR CONSEQUENTIAL DAMAGES. Repair, replacement or return of purchase price by Transcend is the initial purchaser's sole and exclusive remedy under this warranty.

This warranty gives you specific legal rights, and you may also have other rights which vary from state to state. Some states do not allow the exclusion or limitation of incidental or consequential damages, so the above exclusions and limitations may not apply to you.

Warranty claims on a defective product must be made by the initial consumer at the point of purchase within 30 days after the discovery of the defect.

You may contact your authorized Transcend dealer or Transcend at 103 Osborne Road NE, Fridley, Minnesota 55432 USA, 1.877.621.9626 or 1.651.621.1800. See also www.MyTranscend.com/warranty to submit a claim under this limited warranty.

Notices



Notice	The information contained in this document is subject to change without notice.
Trademark	The moon logo, Transcend Micro, WhisperSoft, AirFlex, PowerAway, AirMist, MySleepDash and Transcend are trademarks and/or registered trademarks of Transcend Inc.
Copyright	© Copyright 2023 Transcend Inc.; all rights reserved.

Contact Transcend Inc.

Corporate headquarters



Transcend Inc.

103 Osborne Road NE
Fridley, Minnesota 55432 USA

Email

info@mytranscend.com

Web

<http://www.mytranscend.com>

Telephone

651.621.1800

Toll-free telephone

877.621.9626

Fax

651.204.0064

Rx only

104149 REV D 2024-09