

## Table of Contents

1	Intended Use of the iSleep 20 .....	3
1.1	What is the iSleep 20? .....	3
1.2	Indications for Use .....	4
1.3	Contraindications .....	4
1.4	About this Manual .....	5
2	Safety Information .....	7
2.1	General User Precautions .....	7
2.2	Electrical Safety .....	8
2.3	Environmental Conditions .....	9
2.4	Usage of Patient Circuit .....	10
2.5	Usage of Filters .....	11
2.6	Cleaning and Maintenance .....	11
2.7	Adverse Patient Symptoms .....	12
2.8	Usage of the HA 01 Humidifier .....	13
2.9	Usage of Oxygen .....	14
3	Product Description .....	15
3.1	Main Components .....	15
3.2	Accessories .....	17
3.3	The iSleep 20's Front Panel .....	19
3.4	The iSleep 20's Side Panels .....	20
3.5	Equipment Designation and Safety Label .....	21
4	Functions and Parameters of the iSleep 20 .....	22
4.1	Settings .....	22
4.2	Home and Clinical Mode .....	23
5	Using the iSleep 20 .....	24
5.1	Checking the iSleep 20 before Use .....	24
5.2	Switching the iSleep 20 On and Off .....	24
5.3	Using the Menu .....	25
5.4	Transferring Data between the iSleep 20 and a PC .....	27
5.5	Using the integrated HA 01 Humidifier .....	28
5.6	Using an External Battery .....	29
6	Preparing the iSleep 20 for Use .....	31
6.1	Installing the iSleep 20 .....	31
6.2	Placing the iSleep 20 .....	32
6.3	Connecting the iSleep 20 to the Power Source .....	32
6.4	Connecting the Patient Circuit .....	33
7	Setting up the iSleep 20 .....	34
7.1	Settings Applicable for iSleep 20 .....	35
7.2	Setting the Parameters .....	35
7.3	Viewing Device Information .....	37
8	Internal Function Error .....	39
9	Cleaning the iSleep 20 and Replacement of Accessories .....	40
9.1	Cleaning the iSleep 20 .....	40

9.2	Cleaning and Replacing the Patient Air Filter .....	42
9.3	Change of Patient .....	43
10	Maintenance .....	44
10.1	Regular Maintenance Control .....	44
10.2	Service and Repair.....	45
10.3	Storage.....	45
10.4	Disposal .....	45
11	Technical Specifications .....	46
11.1	System Description .....	46
11.2	Data .....	46
11.3	Compliance of Standards .....	49
11.4	Delivery Settings .....	50
12	Accessories.....	51
12.1	Breas Accessories List.....	51

# 1 Intended Use of the iSleep 20



## WARNING!

iSleep 20 must only be used:

- For the intended treatment in accordance with this manual and with the instructions given by the responsible clinical personnel.
- In accordance with the operating conditions specified in this manual.
- In original and unmodified shape and only with accessories specified or approved by Breas Medical AB.

Every other use may lead to risk of personal injury!



## CAUTION!

Read this manual thoroughly so that you completely understand how the iSleep 20 is operated and maintained before taking it into use, to ensure correct usage, maximum performance and serviceability.



## WARNING!

Do not use the iSleep 20 for any kind of life support treatment.



Breas Medical AB reserves the right to make changes to this product without any prior notification.

## 1.1 What is the iSleep 20?

The iSleep 20 is a CPAP system that provides a continuous positive airway pressure. This can prevent the user's upper airways from collapsing and therefore avoid breathing problems associated with airway collapse and obstruction.

The iSleep 20 has a pressure sensor that continuously monitors output pressure to the patient and reference ambient pressure, so that the device automatically will compensate for altitude changes.

The internal memory of the iSleep 20 can be downloaded to a PC where you can view the patient compliance data in the Breas iSleep PC Software.



*For more information about the Breas iSleep PC Software, please contact your Breas representative.*

## 1.2 Indications for Use

The iSleep 20 is intended for non-invasive use.

The iSleep 20 shall only be used by patients with spontaneous breathing.

The CPAP function is intended to deliver continuous positive airway pressure therapy for the treatment of obstructive sleep apnea in adults (who weigh more than 30 kg).

The iSleep 20 can be used in clinical settings (e.g., hospitals, sleep laboratories, sub-acute care institutions) and home environments. It must always be prescribed by a licensed physician.

The iSleep 20 is intended to be operated by trained users and qualified personnel.



**The iSleep 20 is not intended for life support or life-sustaining applications or for transport of critical care patients.**

## 1.3 Contraindications

Therapy with the iSleep 20 should not be prescribed when the following specific diseases or conditions are present:

- Bullous lung disease
- Pathologically low blood pressure
- Severe cardiac arrhythmias
- Unstable angina pectoris
- Decompensated cardiac failure or hypotension, particularly if associated with intravascular volume depletion
- Recent thoracic surgery

- Pneumothorax
- Pneumomediastinum
- Massive epistaxis or previous history of massive epistaxis (risk of recurrence)
- Pneumoencephalus, recent trauma or surgery that may have produced cranio-nasopharyngeal fistula
- Cerebral spinal fluid (CSF) leaks
- Acute or unstable respiratory failure or insufficiency

Caution should be used when prescribing CPAP therapy for susceptible patients, such as patients with abnormalities of the cribriform plate, or prior history of head trauma.

The use of CPAP therapy may be temporarily contraindicated if the patient exhibits signs of a sinus or middle ear infection.

## 1.4 About this Manual



**Always read this manual before setting up and using the iSleep 20 or performing maintenance on the iSleep 20, to ensure correct usage, maximum performance and serviceability.**



**Breas Medical AB reserves the right to make changes to the contents of this manual without any prior notification.**

### Audience





This manual is primarily intended for care providers, clinical personnel, physicians and others who require a working knowledge of the Breas iSleep 20 system. The manual comprises detailed information on the settings and functions of the iSleep 20 to be handled by trained health care personnel only.



- Patients and other lay users operating the iSleep 20 will find all the information they need in the User Manual.
- Service personnel may order the iSleep 20 Service Manual that contains detailed technical information for maintenance, service and repair.

### Icons

In this manual, icons are used to highlight specific information. The meaning of each icon is explained in the table below.

ICON	EXPLANATION
	<b>Warning!</b> Risk of death and serious personal injury.
	<b>Caution!</b> Risk of minor or moderate injury. Risk of equipment damage, loss of data, extra work, or unexpected results.
	<b>Note</b> Information that may be valuable but is not of critical importance, tips.
	<b>Reference</b> Reference to other manuals with additional information on a specific topic.

## 2 Safety Information

### 2.1 General User Precautions



- The iSleep 20 should not be used for any kind of life support treatment.
- The iSleep 20 shall only be used by patients with spontaneous breathing.
- If the patient is admitted to a hospital or is prescribed any other form of medical treatment, always inform the medical staff that the patient is on CPAP treatment.
- The iSleep 20 must only be used:
  - for the intended treatment in accordance with this clinician’s manual and with the instructions given by the responsible clinical personnel;
  - in accordance with the operating conditions specified in this manual;
  - in original and unmodified shape and only with accessories specified or approved by Breas Medical AB.
- Do not use the iSleep 20 and contact your Breas representative for an inspection in the event of suspected damage to the device, unexplainable or sudden pressure, performance or sound changes during operation, or if the delivered air from the iSleep 20 is abnormally hot or emits an odour.
- The iSleep 20 therapy settings must always be based on medical advice and must be carried out by authorized personnel only.
- Always perform the procedure “Checking the iSleep 20 before Use” on page 24 before use.
- Inadequate use of device or accessories may cause loss of treatment or decreased performance.



- U.S. Federal law restricts this device to sale by or on order of a physician.
- Clinical personnel and the patient must read the manual thoroughly and understand the usage of the iSleep 20 before setting up and using the iSleep 20.
- Handle the iSleep 20 with care.
- Do not use the iSleep 20 while in bag.

## 2.2 Electrical Safety



- Do not operate the iSleep 20 if it has a damaged power cord, power supply or casing.
- The iSleep 20 may not work properly if any part has been dropped, damaged or submerged in water.
- To avoid electrical shock, disconnect the electrical supply to the iSleep 20 before cleaning. Do not immerse the iSleep 20 into any fluids.
- The operator shall not touch accessible contacts of connectors and the patient simultaneously.
- When handling the HA 01 humidifier, disconnect the iSleep 20 from any power source.



- If an external battery is used it must be disconnected when the iSleep 20 is switched off. Otherwise the battery will discharge.
- The performance of the iSleep 20 may deteriorate at:
  - AC supply voltage below -15% and above +10% of declared nominal value.
  - DC supply voltage below -15% and above +25% of declared nominal value.



## 2.3 Environmental Conditions



- Do not use the iSleep 20 in any toxic environment.
- Do not use the iSleep 20 in environments where there are explosive gases or other flammable anesthetic agents present.



- The performance of the iSleep 20 may deteriorate at:
  - ambient temperatures below 41°F (5°C) and above 104°F (40°C).
  - ambient relative humidity below 10% RH (relative humidity) and above 95% RH.
  - atmosphere pressure below 700 mbar and above 1060 mbar.
- Do not use the iSleep 20 while positioned in a warm place, such as direct sunlight.
- The device complies with the EMC requirements of standards listed in “Compliance of Standards” on page 49. Necessary measures should be taken in order to assure field levels exceeding 10 V/m are avoided, since this may impair the safety and performance of the iSleep 20. Measures should include but not be limited to:
  - normal precautions with regard to relative humidity and conductive characteristics of clothing in order to minimize the build-up of electrostatic charges.
  - avoiding use of radio emitting devices closer than 1 m to the iSleep 20. Radio emitting devices are for example cellular or cordless telephones, microwave ovens and high-frequency surgery apparatus.
- The iSleep 20, any accessories and all replaced parts must be disposed of in accordance with the local environmental regulations regarding the disposal of used equipment and waste.
- The performance of the iSleep 20 and treatment of the patient may deteriorate if the operation conditions in “Technical Specifications” on page 46 are not fulfilled. Do not use the iSleep 20 immediately after storage or transport outside the recommended operating conditions.

## 2.4 Usage of Patient Circuit



- Only use the iSleep 20 with a mask and a patient tube recommended by Breas Medical AB and your health care professional.
- Do not breathe in the connected patient circuit unless the iSleep 20 is turned on and operating properly.
- Do not use patient hoses or tubes made of electrically conductive or static material.
- Always use a new mask and a patient tube recommended by Breas Medical AB when the iSleep 20 is to be used by a new patient.
- Patient connected parts and filter must be replaced regularly to ensure correct function of the iSleep 20. All replaced parts must be disposed of according to local environmental regulations regarding the disposal of used equipment and parts.
- If the patient is using a full face mask (covering mouth and nose), the mask must be equipped with a safety entrainment valve.
- Make sure that the leakage ports are never blocked or obstructed. These ports are used for ventilating the mask in order to prevent re-breathing of exhaled air. Re-breathing of exhaled gases for longer than a few minutes can, in some circumstances, lead to suffocation.
- At low CPAP pressures, the air flow through the leakage ports may be inadequate to clear all exhaled gases from the mask. Some re-breathing may occur.

## 2.5 Usage of Filters



- Always use the iSleep 20 with a patient air inlet filter installed. Only use filters that are specified in this manual.
- Replace or clean the filters regularly to ensure correct function of the iSleep 20, especially when changing patient. Failure to replace or clean a dirty filter may cause the iSleep 20 to operate at higher temperatures than intended.
- When operating the iSleep 20, make sure that the air inlet and the filter is not obstructed or occluded.
- If the iSleep 20 is used in a clinic by several patients, a low resistance bacteria filter is recommended between the air outlet and the patient circuit to prevent patient cross-contamination. Reuse of mask or bacteria filter may expose patients to contagious agents.
- Do not connect any filter to the HA 01 humidifier.

## 2.6 Cleaning and Maintenance



- The iSleep 20 shall be cleaned and maintained in accordance with this clinician's manual.
- Do not attempt to autoclave or sterilise the iSleep 20.
- The iSleep 20 shall be subjected to maintenance, service and control and any applicable upgrades, in accordance with Breas service instructions.
- The iSleep 20 should only be repaired or modified in accordance with Breas service manuals, technical bulletins, and any special service instructions, by service technicians authorized by Breas Medical AB.
- Do not under any circumstances attempt to service or repair the iSleep 20 yourself. If you do so, the manufacturer will no longer be responsible for the performance and safety of the iSleep 20.

## 2.7 Adverse Patient Symptoms



If the patient experiences any of the following symptoms while using the iSleep 20, a physician or responsible clinician shall be contacted immediately:

- Bloating feeling from excessive swallowing of air while awake
- Air continually leaking from the mouth while sleeping
- Dryness of air passages or nose
- Ear pain, runny nose or sinus discomfort
- Day time sleepiness
- Disorientation or memory lapse
- Mood change or irritability
- Skin sensitivity
- Morning headache
- Severe headache
- Chest discomfort
- Shortness of breath

## 2.8 Usage of the HA 01 Humidifier



- The HA 01 humidifier and the iSleep 20 are intended for non-invasive use.
- When using an external humidifier, it should be located lower than the iSleep 20 and the patient to prevent personal injury from accidental spillage.
- When using the HA 01 humidifier, the iSleep 20 should be located lower than the patient to prevent personal injury from accidental spillage.
- If a room humidifier is used, place it at least 6 feet (2 meters) away from the iSleep 20.
- Periodically check for moisture in the patient circuit. When present, remove the moisture. Before attempting to dry the circuit, disconnect it from the iSleep 20 to ensure no water back-flow into the iSleep 20. The frequency at which these checks must be performed will depend on the patient's own condition and the device used. This should be assessed on an individual basis in accordance with the patient's needs.
- If the condensation in the patient circuit is excessive, the use of a heated humidifier may require the installation of a water trap in the circuit. The water trap prevents any condensed water in the patient circuit from running into the patient airways and causing personal injury.



- The HA 01 humidifier shall be disconnected from the iSleep 20 during transportation.
- The iSleep 20 shall not be placed in the bag with the HA 01 humidifier attached.

## 2.9 Usage of Oxygen



- The presence of oxygen can speed up combustion of inflammable materials.
- If oxygen has been prescribed, connect the oxygen supply tube to the appropriate oxygen port of the nasal mask or breathing system connector.
- At a fixed flow rate of supplemental oxygen flow, the inhaled oxygen concentration will vary, depending on the pressure delivered, patient's breathing pattern, mask selection, and leak rate.
- When oxygen is used with the iSleep 20, the oxygen flow must be turned off when the iSleep 20 is not operating. If the iSleep 20 is not in operation, and the oxygen flow is left on, oxygen delivered into the patient tubing may accumulate within the iSleep 20 enclosure. Oxygen accumulated in the iSleep 20 enclosure will create a risk of fire.
- Ventilate the room adequately.
- Do not smoke in a room where oxygen is being used.
- Naked light bulbs and other sources of ignition must be kept a minimum of 6 feet (2 meters) away from the oxygen cylinder or any part of the patient circuit.
- Do not use aerosols or solvents close to the oxygen supply, even when the oxygen supply is shut off.

# 3 Product Description

## 3.1 Main Components

The iSleep 20 system contains the following components:

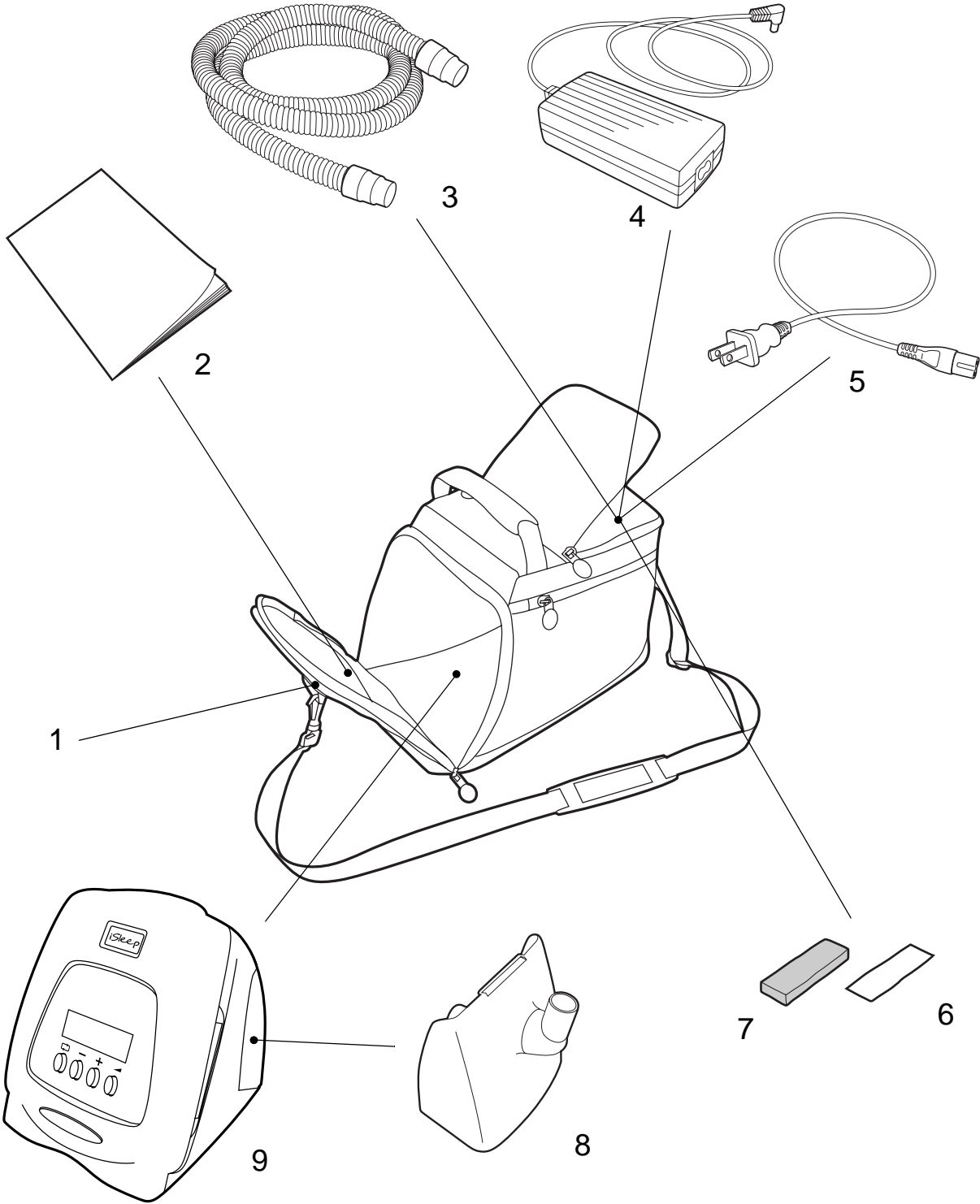

<b>No.</b>	<b>COMPONENT</b>	<b>FUNCTION</b>	<b>PART NO.</b>
1*	Carrying bag	Storage for transportation	003793
2	Users manual	Product and usage information	003907
3	Patient tube	Tube for mask and iSleep 20	000245
4	iSleep 20 power supply		003773
5	AC power cord		003725
6	Filter (white, disposable, optional)	Inlet air filtration	004153 (5 pcs)
7	Filter (grey, washable)	Inlet air filtration	004154 (5 pcs)
8	Rear lid	Usage without HA 01 Humidifier	003591
9	iSleep 20 main unit		

\* Not included in the iSleep 20 basic package.



## 3.2 Accessories

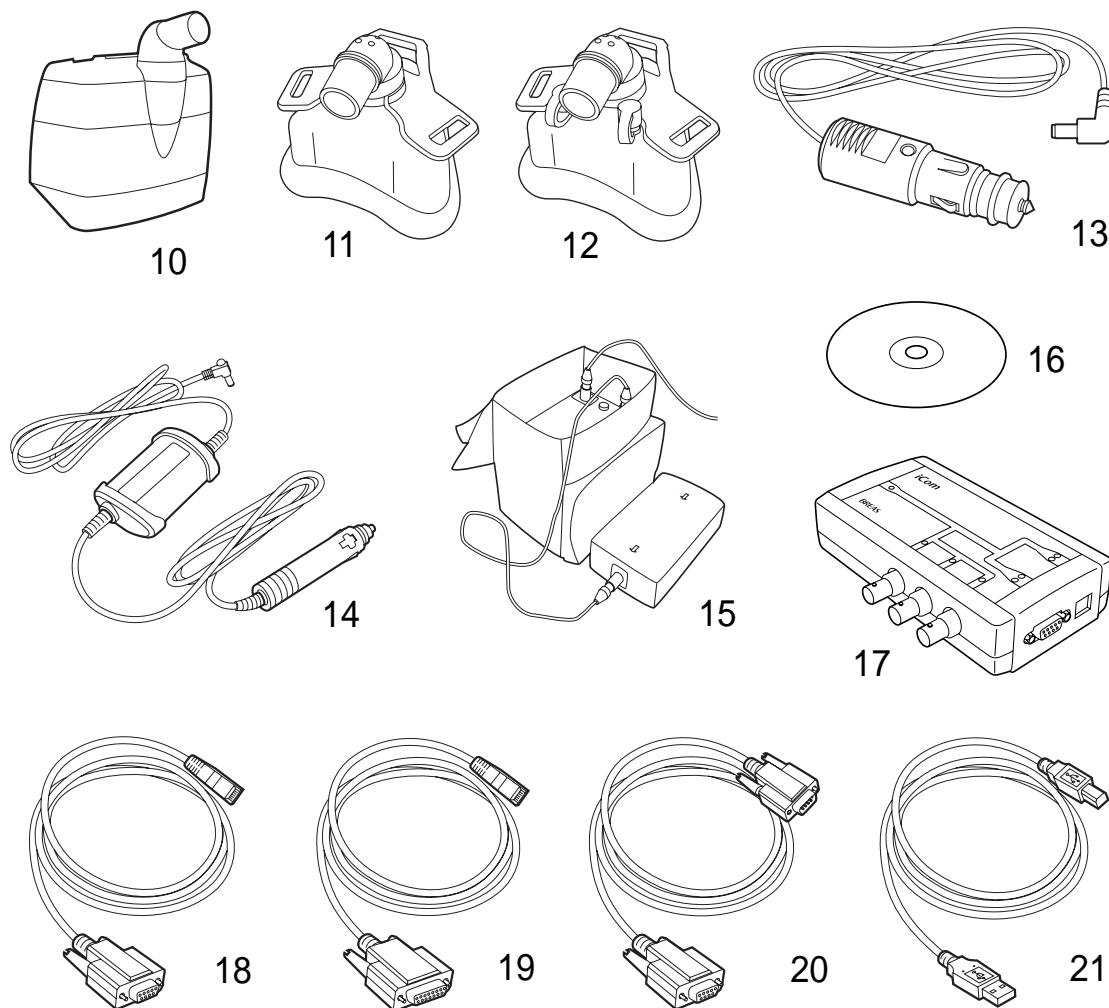

No.	COMPONENT	FUNCTION	PART NO.
10	HA 01 Humidifier	Patient air humidification	003530
11	iMask 100		003971
12	iMask 200		003972
13	Battery cable 24 V DC		004367
14	DC/DC converter 12-24 V		004139

<b>No.</b>	<b>COMPONENT</b>	<b>FUNCTION</b>	<b>PART NO.</b>
15	EB 2 Battery kit	Includes: <ul style="list-style-type: none"> <li>• Charger</li> <li>• Trafobox</li> <li>• Isolation</li> <li>• Battery pack</li> <li>• Carry bag</li> <li>• Power cord 24 V AC</li> <li>• Power cord 24 V DC</li> <li>• Power cord mains</li> <li>• EB 2 User manual</li> </ul>	004152
16	iSleep PC software kit	Data monitoring software	004276
17	iCom kit	Includes: <ul style="list-style-type: none"> <li>• Isolated communication interface: PC and iSleep</li> <li>• iSleep-iCom data cable</li> <li>• iCom-PC data cable (D-sub)</li> <li>• iCom-PC data cable (USB)</li> <li>• iCom User manual</li> <li>• iCom PC drivers</li> </ul>	004143
18	iSleep-PC data cable	Data cable: PC and iSleep 20 (RJ45 to D-sub)	003588
19	iSleep-iCom data cable	Data cable: iSleep 20 and iCom (RJ45 to D-sub)	003574
20	iCom-PC data cable D-sub	Data cable: iCom and PC (D-sub to D-sub)	003721
21	iCom-PC data cable USB	Data cable: iCom and PC (USB to USB)	003722

### 3.3 The iSleep 20's Front Panel

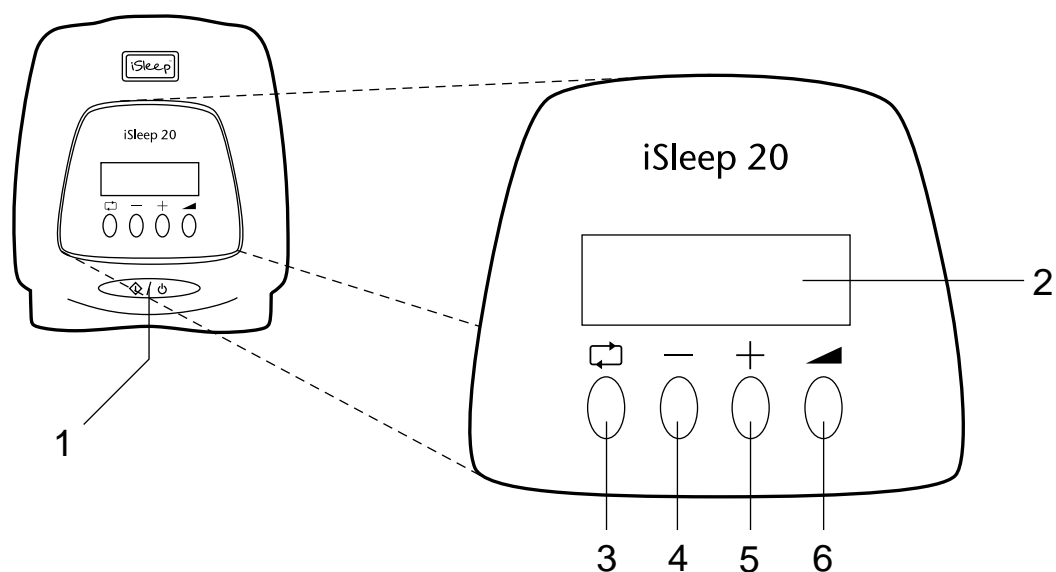

No.	USER BUTTONS AND DISPLAYS	FUNCTION
1	Start/Stop	Main unit: On/Off
2	Display window	Mode and settings display
3	Function	Menu navigation
4	Decrease	Decrease setting
5	Increase	Increase setting
6	Ramp start and stop	Ramp function start and stop



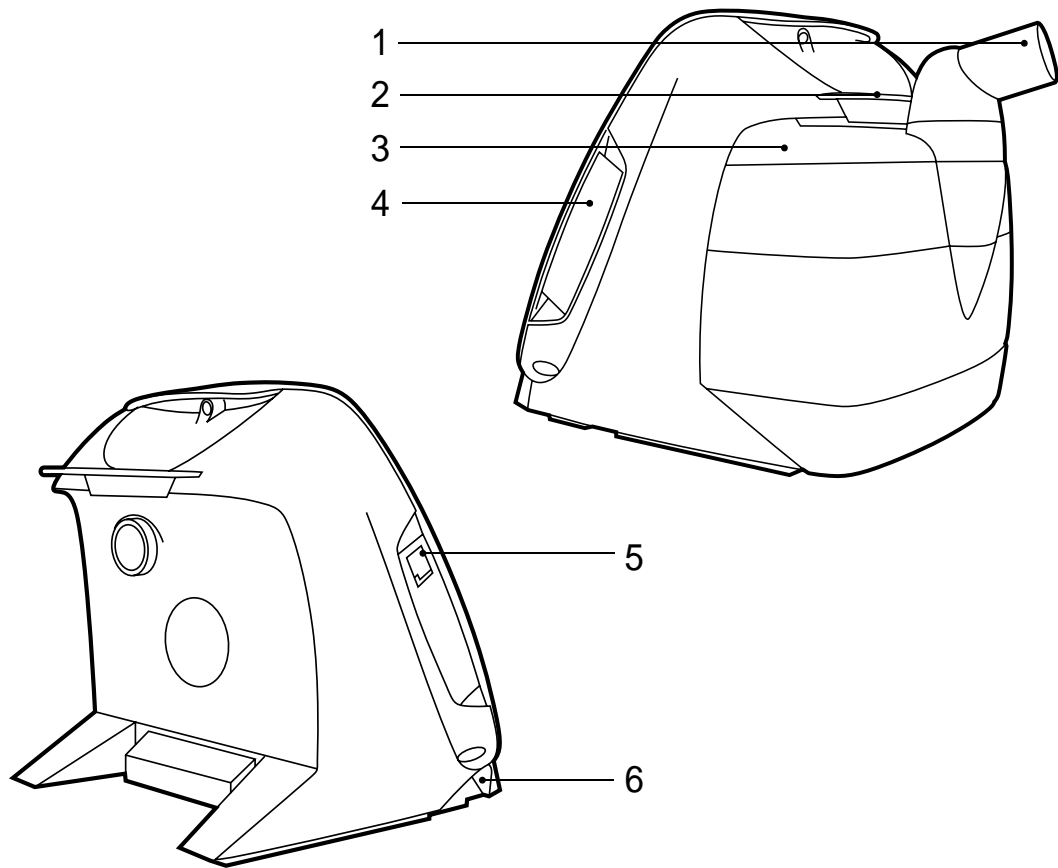



### 3.4 The iSleep 20's Side Panels

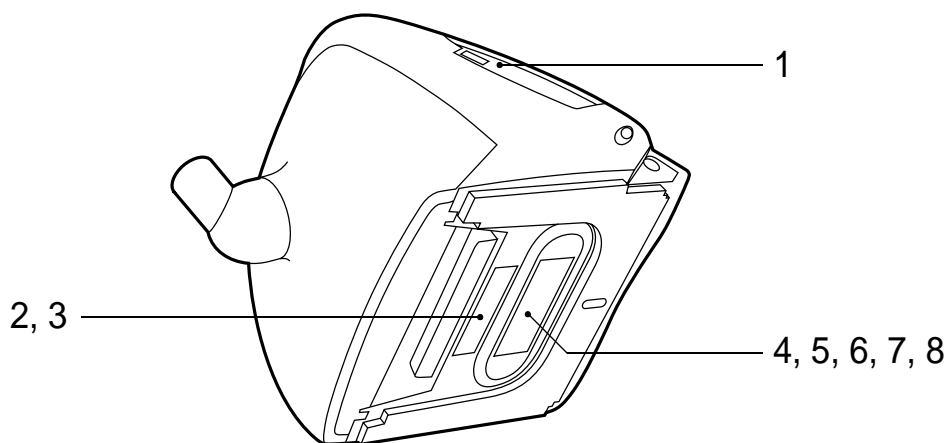

No.	ITEM	FUNCTION
1	Air outlet	Air path out to the patient
2	Locking mechanism	Release and lock HA 01 humidifier or rear lid
3	HA 01 Humidifier (optional)	Patient air humidification
4	Air inlet	Air path in, replaceable filters
5	Data connection	Data cable connection
6	DC inlet	External DC power connection

### 3.5 Equipment Designation and Safety Label



No.	SYMBOL	EXPLANATION
1		Data connection port (for iCom or PC)
2		Model designation
3		Serial number (the last seven alphanumeric characters)
4		Class II electrical equipment; dual isolation
5		Body floating (IEC 60601-1 Type BF, Isolated Applied Part)
6		Read the User Manual thoroughly before connecting the iSleep 20 to the patient.
7		CE marking applies in accordance with the directive MDD 93/42/EEC.
8		Read “Disposal” on page 45 for information about recycling and disposal.

## 4 Functions and Parameters of the iSleep 20

This chapter includes descriptions of the settings used for controlling the functions of the iSleep 20.

### 4.1 Settings

All the parameters that are used for controlling the breathing by the iSleep 20 are listed below.



*Read the chapter “Settings Applicable for iSleep 20” on page 35 for information about the modes and ranges the different settings work with.*

#### CPAP

The CPAP setting sets the pressure for the CPAP (Continuous Positive Airway Pressure) mode.

#### The Ramp Function

The ramp function provides a pressure increase from the ramp start pressure to the set CPAP pressure during a set time.

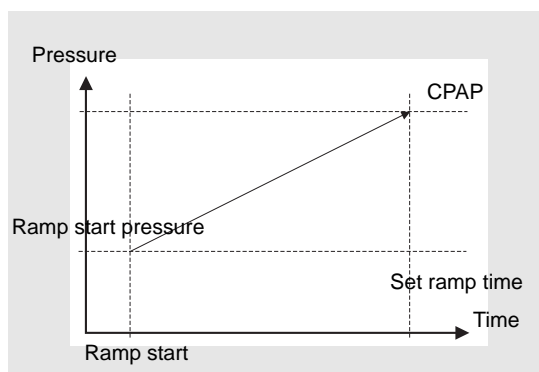

#### Snooze

The snooze function allows the patient to pause the treatment.

#### Humidifier (optional)

The humidifier function is adjustable to provide additional humidity to the patient air.

#### Automatic Restart After Power Fail

The iSleep 20 will restart after a power failure with a duration shorter than 5 seconds.

### **Wake Up (optional)**

The wake up function will initiate an alarm at a set time when activated.

## **4.2 Home and Clinical Mode**

In order to prevent the patient to change the settings, the home mode shall be activated before giving the iSleep 20 to the user. The home mode hides treatment settings and other selected information.

The clinical mode is used by the clinician to control all mode choices, settings and limits. While operating in clinical mode, the iSleep 20 shows the actual measured pressure in the main display window. Read the chapter “Using the Menu” on page 25 for more information.



## 5 Using the iSleep 20

### 5.1 Checking the iSleep 20 before Use

Always make the following checks before using the iSleep 20:

- 1 Connect a cleaned or a new patient circuit to the iSleep 20.
- 2 Connect the iSleep 20 to the AC supply.
- 3 Check patient settings.
- 4 Switch on the iSleep 20 by pressing the Start/Stop button on the front panel. Ensure that the iSleep 20 is running.
- 5 Put on the mask and adjust its fit.
- 6 Ensure that the settings are adjusted as prescribed.

The iSleep 20 is ready for use.

### 5.2 Switching the iSleep 20 On and Off

- 1 Make sure the power supply is connected.

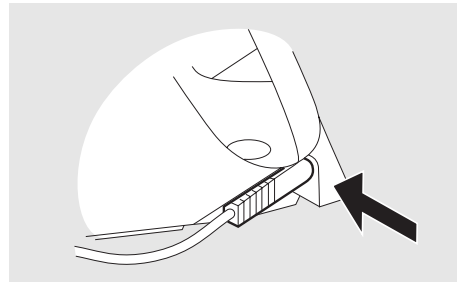

- 2 Turn on the iSleep 20 by pressing the Start/Stop button on the front panel for 2 seconds.

This operation switches the iSleep 20 between standby and operating mode.

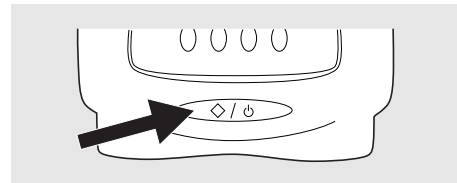

The iSleep 20 is connected to a power supply when the LCD display is lit up.



## 5.3 Using the Menu



Read chapter “The iSleep 20’s Front Panel” on page 19 for exact position of the buttons.

Use the function button to toggle through the different functions of the iSleep 20.

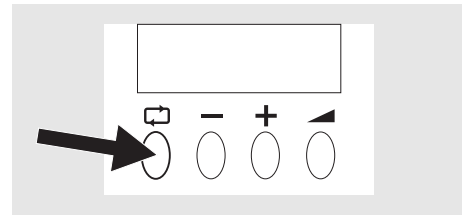

The plus (“+“) and minus (“-“) buttons are used to alter a value.

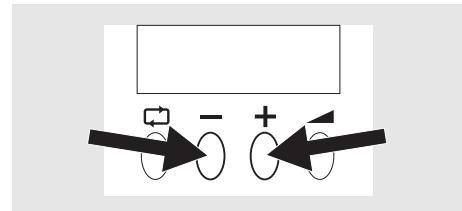

The ramp button is used to activate the ramp function during operation.

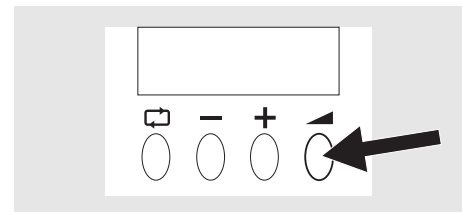



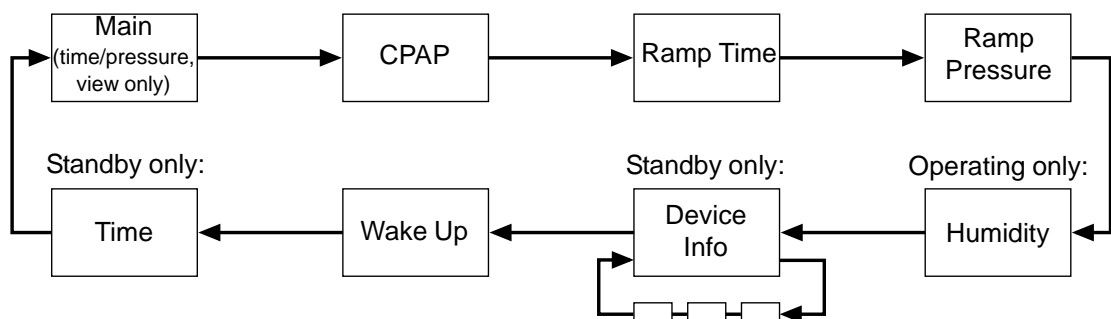

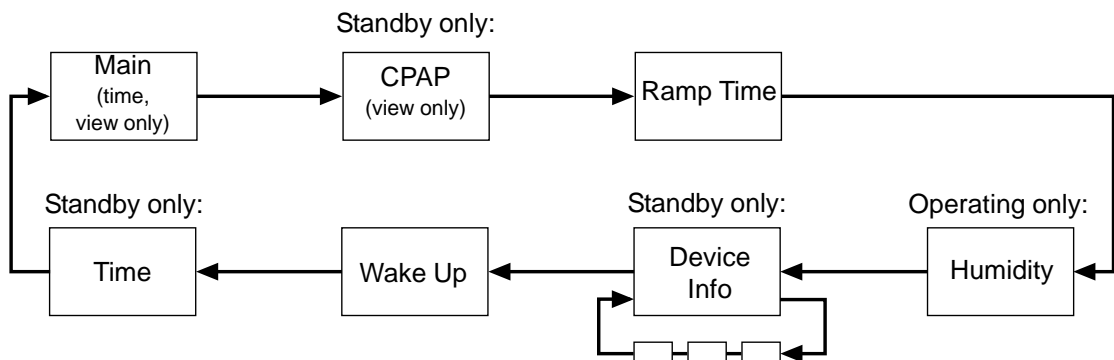

### Clinical Mode Overview



### Home Mode Overview



## Icons in the Display Window

ICON	EXPLANATION
	Pressure
	Time
	Ramp
	Humidity
	Information
	Wake Up Alarm
	Panel lock

## Switching between Clinical and Home Mode

Keep the “+” and “-” buttons pressed for 5 seconds.

Home mode is indicated by the panel lock.

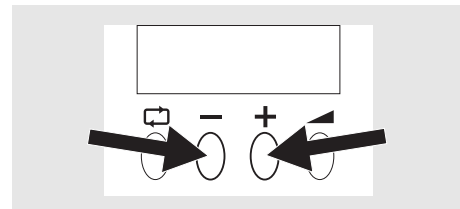

## 5.4 Transferring Data between the iSleep 20 and a PC



In order to view and present patient data correctly, the Breas iSleep PC Software must be installed on the PC.

The iSleep 20 records AHI (Apnea Hypopnea Index).



*Instructions on how to manage data in the Breas iSleep PC Software can be found in the software help.*

### Data Cable



**The data cable shall not be used for data transfer while the patient is connected to the iSleep 20. Only a PC which complies to the IEC 60601-1 standards can be used for transferring data during treatment of a patient.**

The data cable can receive and send data between the iSleep 20 and a PC.

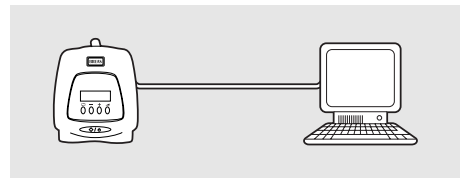

**1** Connect the data cable to the iSleep 20. Make sure it is fitted correctly.

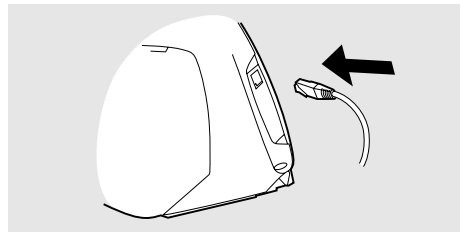

**2** Connect the other end of the data cable to the PC with the RS232 connector.

### iCom Communication Unit



The iCom can be used to transfer data between the iSleep 20 and a PC during treatment of a patient. The PC does not need to comply with the IEC 60601-1 standard if the iCom is used.

With the iCom, real-time data can be received and sent between the iSleep 20 and a PC.

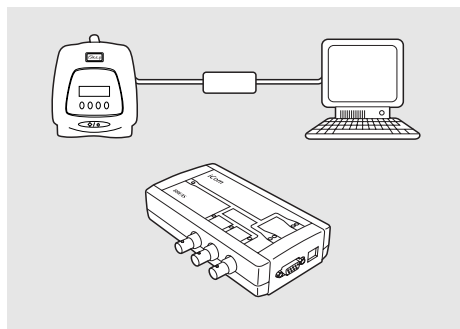

1 Connect the iSleep-iCom data cable to the iSleep 20. Make sure it is fitted correctly.

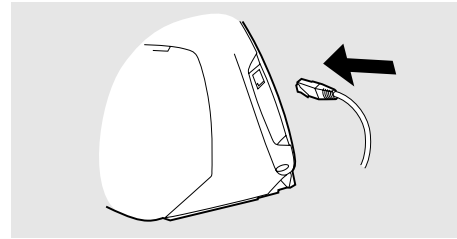

2 Connect the other end of the iSleep-iCom data cable to the iCom.

3 Connect the iCom-PC data cable between the iCom and a PC. Only use either the D-sub cable or the USB cable.

## 5.5 Using the integrated HA 01 Humidifier



Read the chapter “Usage of the HA 01 Humidifier” on page 13 carefully to make sure all conditions are fulfilled and considered.



See chapter “Humidifier (optional)” on page 36 for instructions how to set up the HA 01 humidifier.

*Instructions about safety, warnings, product description, using, cleaning and technical information can be found in the Breas HA 01 humidifier User Manual.*



If the HA 01 humidifier is refilled according to instructions after usage, the iSleep 20 will remember the humidity setting used.

The HA 01 humidifier is intended to humidify the patient air. The HA 01 humidifier must be installed in order to access and navigate to this setting, both clinical and home mode.

A full HA 01 humidifier will be able to humidify the air for about 11 hours with the following settings and conditions:

SETTING	VALUE
Humidifier setting	5
CPAP pressure	10 cmH <sub>2</sub> O
Ambient temperature	68°F (20°C)
Leakage	20 l/min
Altitude	Sea level

## 5.6 Using an External Battery

The iSleep 20 can be powered from:

- The Breas external EB 2 Battery Pack.
- A 12 V external power source. The iSleep DC/DC converter 12-24 V needs to be used.
- A 24 V external power source. The iSleep battery cable needs to be used.

**1** Connect the external DC cable to the iSleep 20. Make sure it is fitted correctly.

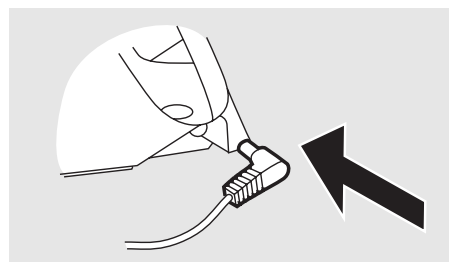

**2** Connect the other end of the cable to the battery source.



- Always make a function check to test the battery condition before operating the iSleep 20 from an external battery source.
- The battery must be disconnected when the iSleep 20 is switched off, otherwise the battery will be discharged.

### Battery Operation Time

The operation time is dependent on the battery condition, its capacity, the ambient air temperature and the iSleep 20 pressure setting.

The operation time is based on the following settings:

SETTING	VALUE
Humidifier setting	5 or Off
CPAP pressure	10 cmH <sub>2</sub> O
ENVIRONMENTAL CONDITIONS	
Ambient temperature	68°F (20°C)
Altitude	Sea level
Battery status	New battery fully charged

BATTERY TYPE	HUMIDIFIER	OPERATION TIME
EB 2 (24 V, 7.2 Ah)	Off	13 h
EB 2 (24 V, 7.2 Ah)	5	Not recommended
Car battery (12 V, 60 Ah)*	Off	90 h
Car battery (12 V, 60 Ah)*	5	25 h

\* When using a 12 V external power, the iSleep DC/DC converter 12-24 V needs to be used.

## 6 Preparing the iSleep 20 for Use



Read the chapter “Safety Information” on page 7 before setting up and using the iSleep 20.

### 6.1 Installing the iSleep 20

When using the iSleep 20 for the first time, follow the instructions below:

**1** Check that all main components and ordered accessories have been delivered (refer to the packing note or the invoice, if available).

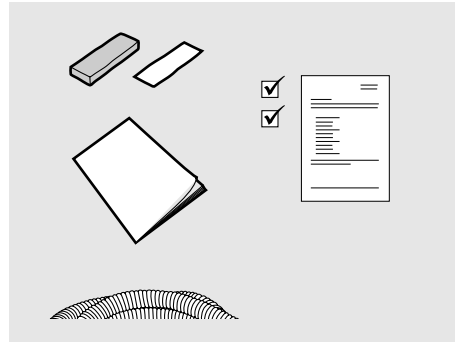

**2** Ensure that the equipment is in good condition.

**3** Check that the mandatory grey patient air filter is installed.

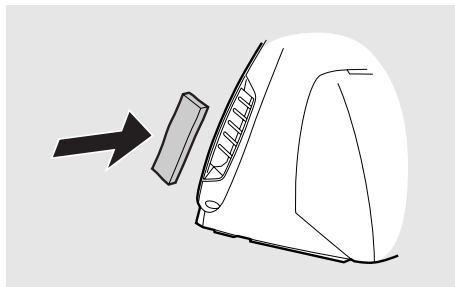

## 6.2 Placing the iSleep 20



Read the chapter “Environmental Conditions” on page 9 carefully to make sure all conditions are fulfilled and considered.

1 Place the iSleep 20 on a solid, flat surface. The iSleep 20 should be placed lower than the patient in order to prevent the device from falling on the patient, as well as preventing condensed water to reach the patient.

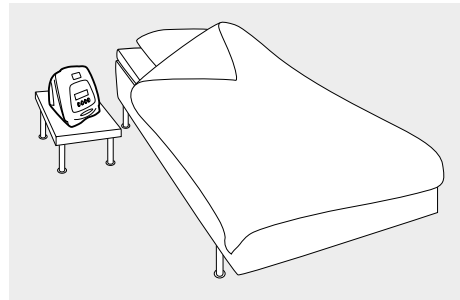

2 Make sure that nothing can block the patient air inlet at the side of the iSleep 20.

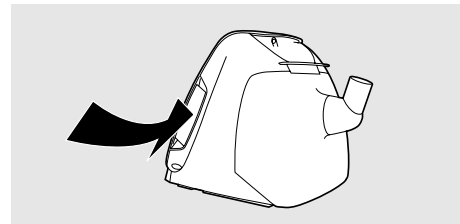

## 6.3 Connecting the iSleep 20 to the Power Source



Read the chapter “Electrical Safety” on page 8 carefully to make sure all conditions are fulfilled and considered.

**To Connect the iSleep 20 to the Power Source:**

1 Plug the power supply into the power inlet of the iSleep 20.

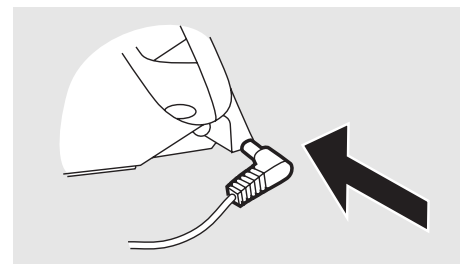

2 Connect the power cord into the power supply.

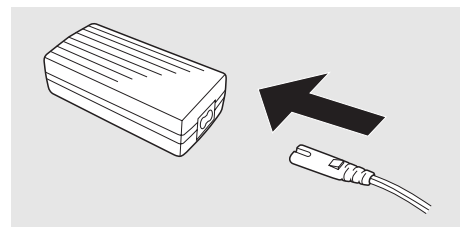



**3** Connect the power cord to the power source.

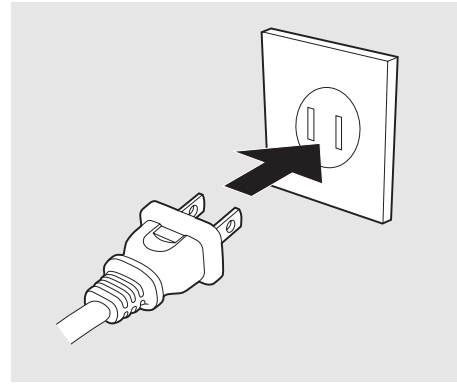

## 6.4 Connecting the Patient Circuit



Read the chapter “Usage of Patient Circuit” on page 10 carefully to make sure all conditions are fulfilled and considered.

**1** Connect the patient tube to the air outlet.

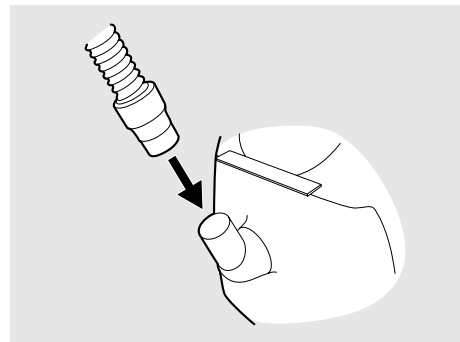

**2** Connect the other end of the patient tube to the mask and the leakage port, if applicable.

### Mask Leakage

The leakage from the mask should be at least 12 l/min at 4 cmH<sub>2</sub>O, to prevent re-breathing of exhaled air. The recommended mask leakage is 20-40 l/min at 10 cmH<sub>2</sub>O pressure.

This leakage may be achieved by:

- small holes in the mask
- an adjoining leakage port



In order to receive a suitable leakage the Breas iMask™ Nasal CPAP Mask is recommended.

## 7 Setting up the iSleep 20



Read the chapter “Safety Information” on page 7 before setting up and using the iSleep 20.



- The configuration of the iSleep 20 therapy settings must always be prescribed by a licensed physician and carried out by an authorized health care professional.
- Always document the set values before the patient returns home.

This chapter describes how to set the different parameters that are used for controlling the operation of the iSleep 20.

## 7.1 Settings Applicable for iSleep 20

SETTING	RANGE	RESOLUTION
CPAP	4 to 20 cmH <sub>2</sub> O	0.5 cmH <sub>2</sub> O
Ramp time	5 to 60 min	5 min
Ramp start pressure	4 cmH <sub>2</sub> O to CPAP	0.5 cmH <sub>2</sub> O
Humidifier	Off, 1 to 9	1



*The operation modes and setting parameters are described in detail in the chapter “Functions and Parameters of the iSleep 20” on page 22.*

## 7.2 Setting the Parameters



*For more information about how to use the menu, please read the chapter “Using the Menu” on page 25.*

*Study the overview pictures in “Using the Menu” on page 25 if a page or section can not be found.*

### CPAP

Setting range: 4 to 20 cmH<sub>2</sub>O.

Resolution: 0.5 cmH<sub>2</sub>O.

Navigate to the “CPAP” section.



## The Ramp Function

Setting range: 5 to 60 min.

Resolution: 5 min.

Navigate to the “Ramp” section. The ramp function can only be activated during operation.

When the “Ramp” section is available in the menu, the ramp function can be activated and deactivated by pressing and holding the “Ramp” button until the ramp symbol appears/disappears.

Ramp pressure: 4 cmH<sub>2</sub>O to CPAP.

Resolution: 0.5 cmH<sub>2</sub>O.



The first time the ramp function is activated, the iSleep 20 will immediately start the ramp. The following activations in the same treatment session will have a 10 second delay before starting the ramp function. This is indicated by flashing the ramp time.

## Humidifier (optional)

Setting range: 1 to 9, Off (where 9 is the maximum humidity).

Navigate to the humidifier section by using the function button. If the HA 01 humidifier is not attached to the iSleep 20, the “Humidity” section will not be available in the menu.

When the humidifier icon flashes, press the “+” button. Set the humidity level using the “+” and “-” buttons. Save the setting by pressing the function button.



The HA 01 humidifier can only be activated during operation.

## Snooze

The snooze is activated by shortly pressing the Start/Stop button. When the snooze is started, the display will lighten up and cycle between 4 lines and pressure. The iSleep 20 will deliver a low flow.

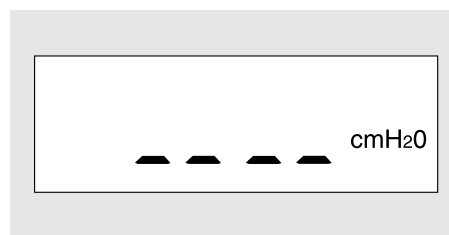

In order to start the treatment again, start to breath in the mask or press the Start/Stop button shortly. The iSleep 20 will then increase the pressure to the set level during up to 10 seconds.



- The iSleep 20 will turn off automatically after 10 minutes of inactivity once the snooze function has been activated.
- Once the snooze is activated, and the mask has not been taken off within 10 seconds, the pressure will rise to the pressure set before the snooze function was activated.

## Wake Up (optional)

Navigate to the “Wake Up” section.



When the wake up alarm icon flashes, press the “+” button. Set the time using the “+” and “-“ buttons. Continue from the hour setting to the minutes setting by pressing the function button.

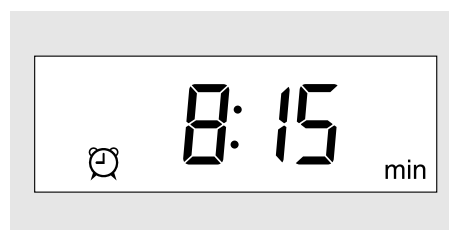

The wake up alarm is active when the wake up alarm icon is visible in the display.

## 7.3 Viewing Device Information



*Check the chapter “Using the Menu” on page 25 for information about how to navigate to the device info screen.*

Navigate to the “Device Info” section (in standby only). Use the “+” button to cycle through the screens.

The “Device Info” section contains three information screens:

- 1 Patient Operating Time:**  
Total number of hours a patient has been using the iSleep 20 for CPAP treatment (ramp not included).
- 2 Total Operating Time:**  
Total number of hours the iSleep 20 has been operating.
- 3 Firmware version.**

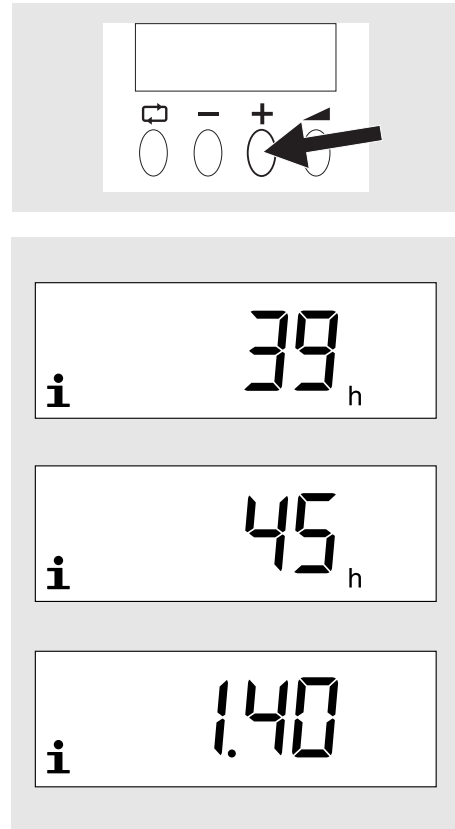

## 8 Internal Function Error

The indication function of the iSleep 20 consists of a message shown in the display window.

ITEM	DESCRIPTION
<b>Definition</b>	<p>An internal function error will be given when the iSleep 20 has an internal function failure. The following error codes exist:</p> <ul style="list-style-type: none"><li>• 20: Function error.</li><li>• 21: Low power. Check the power cables and the AC connection.</li><li>• 28: Low humidifier temperature. Check that the HA 01 humidifier is connected correctly (this error is shown after the treatment session). If the error remains, contact service personnel.</li><li>• 29: High humidifier temperature. Turn off the iSleep 20. Disconnect the HA 01 humidifier and reconnect it. If the error remains, contact service personnel.</li><li>• 30: High temperature. Let the iSleep 20 cool down and restart. The ambient temperature might be too high.</li><li>• 61: Check settings. Check that the settings of the iSleep 20 are according to prescription.</li></ul>
<b>Action</b>	<p>The iSleep 20 will continue or stop the treatment depending on the type and priority of the event.</p>
<b>Indication</b>	<p>The indication is asserted audibly with a tone and visibly by a display message.</p>
<b>Reset</b>	<p>If possible, correct the error cause and disconnect and connect the AC power source.</p>

## 9 Cleaning the iSleep 20 and Replacement of Accessories

The patient-connected parts and the filter must be cleaned and replaced regularly to ensure correct function of the iSleep 20. All replaced parts must be disposed of in accordance with local environmental regulations regarding the disposal of used equipment and waste.

### 9.1 Cleaning the iSleep 20



To avoid electrical shock, disconnect the power supply to the iSleep 20 before cleaning. Do not immerse the iSleep 20 into any fluids.



- Always be careful when cleaning to ensure that you do not damage any equipment.
- Fluid must not be allowed to enter into the iSleep 20.
- Do not sterilise the iSleep 20.

#### Main Unit

1 Switch off the iSleep 20 and disconnect the power supply.

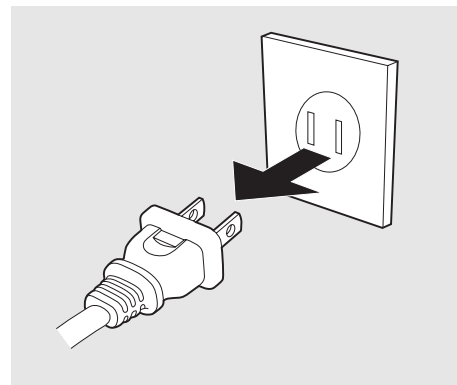

2 Remove the patient circuit.

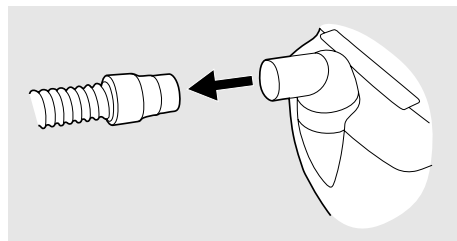



**3** Detach the rear lid or the HA 01 humidifier (if mounted).

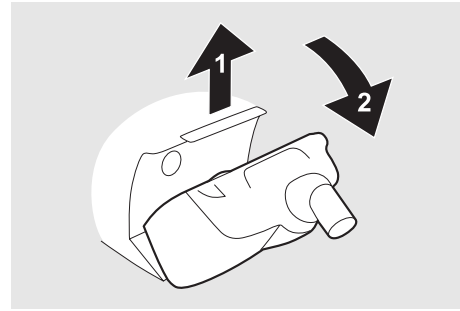

**4** Disconnect all cables.

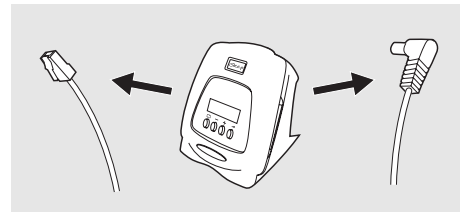

**5** Clean the outside of the iSleep 20 using a lint-free cloth and a mild detergent solution. If the iSleep 20 needs to be disinfected, this can be done with Virkon® or Lysetol® Med.

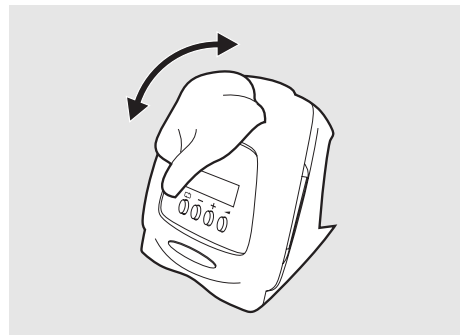

**6** Reconnect cables and the patient circuit. Make sure all parts are dry before the iSleep 20 is put into operation.

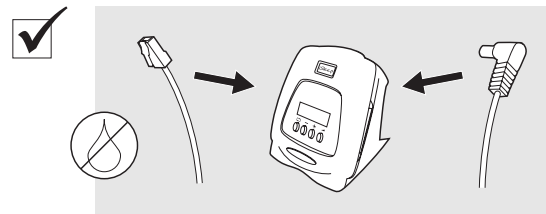

### HA 01 Humidifier

The HA 01 humidifier must be cleaned regularly.



*Information on cleaning the HA 01 humidifier can be found in the Breas HA 01 humidifier User Manual.*

The HA 01 humidifier shall be replaced in intervals according to the manufacturer's instructions. Also check the HA 01 humidifier for damage regularly. In case of damage, replace the HA 01 humidifier.

### Patient Circuit



*The patient circuit should be cleaned and replaced in accordance with the manufacturer's instructions.*

Always clean the parts or use a new set when used by a new patient.

All parts that come into contact with the respiration gas must be cleaned as follows:

- 1 Place the dismantled parts in hot water containing washing-up liquid.
- 2 Remove fouling with a brush.
- 3 Rinse parts thoroughly under running hot water.
- 4 Shake water out of all parts.
- 5 Dry the parts completely.
- 6 Store in dust-free location.

Check the patient circuit for damage regularly. In case of damage, replace the circuit.

If the parts need to be disinfected, this can be done in a bath of Virkon® or Lysetol® Med, for instance. Then rinse the parts well in clear water and dry them thoroughly.

## 9.2 Cleaning and Replacing the Patient Air Filter

The patient air filter is located on the side of the iSleep 20. There are two types of filters:

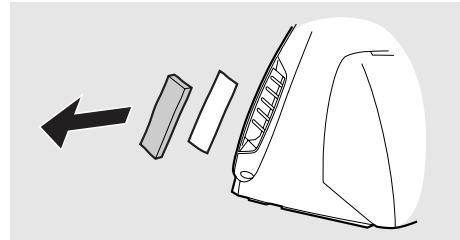

### **Washable Filter (grey color, mandatory)**

Replace the washable filter at least once a year. Wash the filter at least once a week.

- 1 Wash the filter using warm water and a mild detergent.
- 2 Rinse thoroughly.
- 3 Dry the filter by squeezing it out in a towel. Do not wring the filter.

### **Disposable Filter (white color, optional)**

Replace the filter at least every 4th week, or more often when used in high pollution or pollen-rich environments.



**Do not wash or reuse the disposable filter.**

### **9.3 Change of Patient**

If the iSleep 20 is used in a clinic by several patients, a low resistant bacteria filter may be used between the air outlet and the patient tube to prevent patient cross-contamination. A low resistant bacteria filter should not be used with the HA 01 humidifier.

- 1** Follow the instructions in “Cleaning the iSleep 20” on page 40, step 1 to 5.
- 2** Clean the humidifier according to the Breas HA 01 humidifier User Manual.
- 3** Replace the patient filter according to “Cleaning and Replacing the Patient Air Filter” on page 42.
- 4** If a low resistant bacteria filter is used, it shall be replaced.
- 5** Use a new patient circuit when the iSleep 20 is used by a new patient.

## 10 Maintenance



### **WARNING!**

- iSleep 20 should be subjected to maintenance, service and control and any applicable upgrades, in accordance with Breas service instructions.
- iSleep 20 should only be repaired or modified in accordance with Breas service manuals, technical bulletins, and any special service instructions, by service technicians that have been authorized after Breas iSleep 20 service training.
- Do not under any circumstances attempt to service or repair the iSleep 20 yourself. If you do so, the manufacturer will no longer be responsible for the performance and safety of the iSleep 20.

**DEVIATION FROM THESE SERVICE INSTRUCTIONS MAY LEAD TO RISK OF PERSONAL INJURY!**

### 10.1 Regular Maintenance Control

The iSleep 20 should not require any regular maintenance inspections if it is used and maintained in accordance with the instructions in this manual.



**Do not use the device and contact your responsible care provider for an inspection of the device in the event of:**

- Unexpected patient symptoms during treatment.
- Unexplainable or sudden pressure, performance or sound changes during operation.
- Suspected damage to the device or power supply.

## 10.2 Service and Repair

The service and repair of the iSleep 20 must only be carried out by authorized service personnel in accordance with Breas service instructions. Service inspections must always be carried out after any repair of the device.



*Authorized service workshops can order the iSleep 20 Service Manual that contains all technical documentation required for the maintenance and service of the iSleep 20.*

## 10.3 Storage

Empty, clean and dry the HA 01 humidifier (if applicable) before storage of the iSleep 20.

## 10.4 Disposal

The iSleep 20, any accessories and all replaced parts must be disposed of and recycled in accordance with the local environmental regulations regarding the disposal of used equipment and waste.

# 11 Technical Specifications

## 11.1 System Description

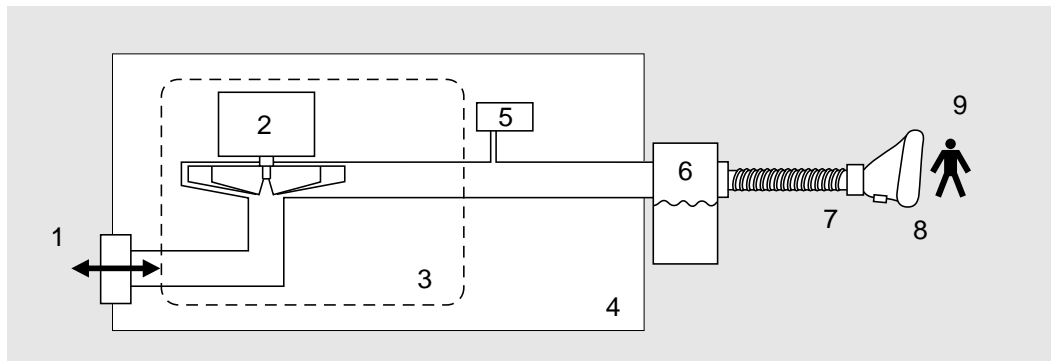

No.	DESCRIPTION
1	Air inlet filter
2	Blower
3	Silencer box
4	iSleep 20 casing
5	Pressure sensor
6	Humidifier
7	Patient tube
8	Leak hole
9	Mask

## 11.2 Data

SETTING/VALUE	RANGE/SPECIFICATION	RESOLUTION
Device modes	<ul style="list-style-type: none"> <li>Clinical</li> <li>Home</li> </ul>	
CPAP	4 to 20 cmH <sub>2</sub> O	0.5 cmH <sub>2</sub> O
Ramp time	5 to 60 min	5 min
Ramp start pressure	4 cmH <sub>2</sub> O to CPAP	0.5 cmH <sub>2</sub> O

SETTING/VALUE	RANGE/SPECIFICATION	RESOLUTION
Humidifier	1 to 9, 10 to 30 mgH <sub>2</sub> O/l, <100% RH. Heat-up time from 73°F: 1 hour. Max gas temperature at patient port: 106°C.	1
Maximum limited pressure during single fault condition	30 cmH <sub>2</sub> O	
Max flow in CPAP mode	6.7 cmH <sub>2</sub> O: 90 l/min 13.3 cmH <sub>2</sub> O: 130 l/min 20 cmH <sub>2</sub> O: 160 l/min	
Breathing resistance under single-fault	0.8 cmH <sub>2</sub> O at 30 l/min 2.8 cmH <sub>2</sub> O at 60 l/min	
Digital output	0 to 5 V	
Sound level at 10 cmH <sub>2</sub> O	Less than 30 dB(A). Measured at 1 m.	

INDICATIONS	SPECIFICATION	TOLERANCE
Pressure	0 to 20 cmH <sub>2</sub> O	±2% of full scale reading, ±4% of the actual reading
Internal function indication	Message shown in the display.	

POWER SUPPLIES	SPECIFICATION
AC supply	100 to 240 V AC, tolerance: -15%/+10%, 50 to 60 Hz, max 140 VA. DC output: 24 V.
External DC supply	24 V DC, tolerance: -15%/+25% (20.4 to 30 V). Max 2.5 A, 60 W with Breas external battery.
Standby power	3 W

<b>ENVIRONMENTAL CONDITIONS</b>	<b>SPECIFICATION</b>
Operating temperature range	41 to 104°F (5 to 40°C)
Storage and transport temperature	-4 to +140°F (- 20 to +60°C)
Ambient pressure range	700 to 1060 mbar
Humidity	10% to 95%, non-condensing

<b>OPERATING CONDITIONS</b>	<b>SPECIFICATIONS</b>
Recommended leakage	20 to 40 l/min at 10 cmH <sub>2</sub> O
Minimum leakage	12 l/min at 4 cmH <sub>2</sub> O

<b>DIMENSIONS</b>	<b>SPECIFICATIONS</b>
W × H × D	173 × 172 × 209 mm (with rear lid) 173 × 172 × 201 mm (with HA 01 humidifier)
Weight	1.3 kg (with rear lid), 1.4 kg (with HA 01 humidifier)
Air outlet	22 mm male conical standard connector



## 11.3 Compliance of Standards

STANDARD	SPECIFICATIONS
IEC 60601-1 (1988) A1 (1991) A2 (1995)	Medical electrical equipment - Part 1: General requirements for safety.
IEC 60601-1-1 (2000)	Medical electrical equipment - Part 1-1: General requirements for safety - Collateral standard: Safety requirements for medical electrical systems.
IEC 60601-1-2 (2001)	Medical electrical equipment - Part 1-2: General requirements for safety - Collateral standard: Electromagnetic compatibility - Requirements and tests.
IEC 60601-1-4 (2000)	Medical electrical equipment - Part 1-4: General requirements for safety - Collateral Standard: Programmable electrical medical systems.
ISO 17510-1 (2001)	Sleep apnea breathing therapy - Part 1: Sleep apnea breathing therapy devices.
ISO 8185 (1997) C1(2001)	Humidifiers for medical use - General requirements for humidification systems.

CLASSIFICATIONS	SPECIFICATIONS
Class IIa	Classification according to the European Medical Device Directive 93/42/EEC.
Class II	FDA classification
Class II (IEC 60601-1) Class II, Type BF	Electrical equipment with dual isolation and body floating (isolated) applied part according to IEC 60601-1.
IPX1	Degree of protection provided by enclosure.



The iSleep 20 and its packaging do not contain any natural rubber latex.

## 11.4 Delivery Settings

<b>MODES AND FUNCTIONS</b>	<b>DELIVERY</b>
Ramp	Off
Clinical	On
Home	Off
Humidifier	Off
Wake up	Off

<b>PARAMETERS</b>	<b>DELIVERY</b>
CPAP	8 cmH <sub>2</sub> O
Ramp time	10 min
Ramp start pressure	4 cmH <sub>2</sub> O

<b>OTHERS</b>	<b>DELIVERY</b>
Time format	24h
Total operating time	<100 h
Total patient operating time	0 h
Pressure unit	cmH <sub>2</sub> O
Wake up time	7:30

## 12 Accessories

### 12.1 Breas Accessories List



Only use accessories recommended by Breas Medical AB. Breas Medical AB cannot guarantee the performance and safety for the use of other accessories with the iSleep 20.

The following Breas accessories are currently available for the iSleep 20:

DESCRIPTION	PART No.
Carrying bag	003793
Users manual	003907
Clinician's manual	003923
Patient tube	000245
HA 01 Humidifier	003530
Rear lid	004116
Filter (grey, washable)	004154 (5 pcs)
Filter (white, disposable, optional)	004153 (5 pcs)
iMask 100	003971
iMask 200	003972
Low resistant bacteria filter (303 Respirgard-II Filter)	004185
Breas one-size headgear	003434
iSleep 20 power supply	003773
AC power cord	003725
EB 2 external battery pack 24 V DC, including cable, charger and bag	004152
External DC cable (EB 2)	004136
TrafoBox EB 2 external battery	001153
Charger EB 2 external battery	001159
Carrying bag EB 2 external battery	000269

DESCRIPTION	PART No.
EB 2 power cord	000541
Battery cable 24 V DC	004367
iSleep DC/DC converter 12-24 V	004139
iSleep PC software kit	004276
iCom kit	004143
iSleep-PC data cable, RJ45 to D-sub 9F	003588
iSleep-iCom data cable, RJ45 to D-sub 15F	003574
iCom-PC data cable, D-sub 9M to D-sub 9F	003721
iCom-PC data cable, USB to USB	003722



Accessory equipment connected to the analog and digital interfaces must be certified according to the respective IEC standards (e.g. IEC 60950 for data processing equipment and IEC 60601-1 for medical equipment). Furthermore all configurations shall comply with the valid version of the system standard IEC 60601-1-1. Everybody who connects additional equipment to the signal input part or signal output part configures a medical system, and is therefore responsible that the system complies with the requirements of the valid version of the system standard IEC 60601-1-1. If in doubt, consult the technical service department or your local Breas representative.