



ResMed

 **RespShop**

AirFit™ N20

Nasal mask



User guide
English | 简体中文
繁體中文

Fitting / 配戴 / 配戴

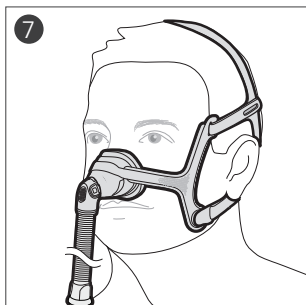
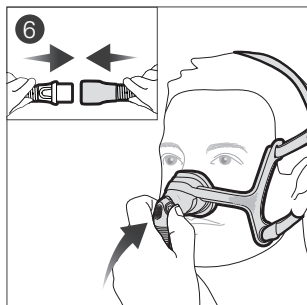
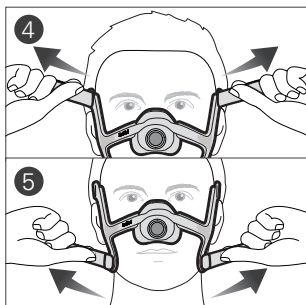
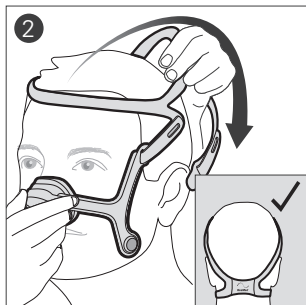
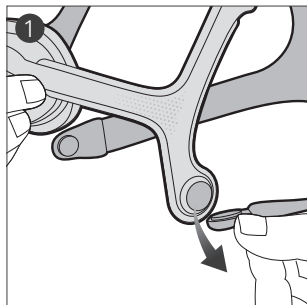

Adjustment / 调整 / 調整

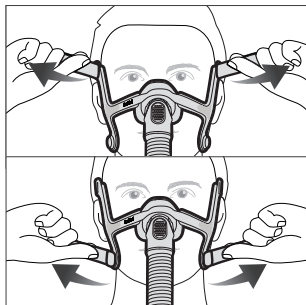
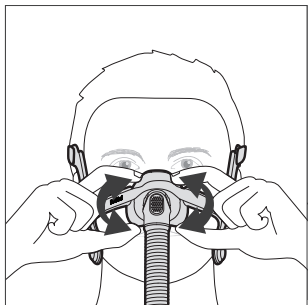

Removal / 取下面罩 / 取下面罩

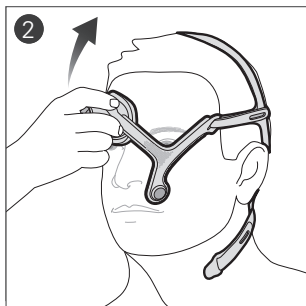
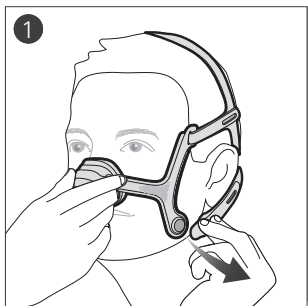

Disassembly / 拆卸 / 拆卸

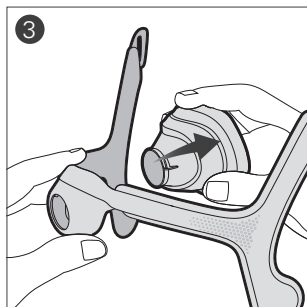
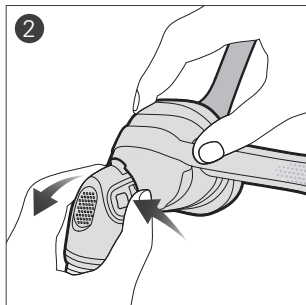
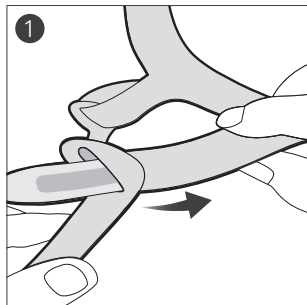

Reassembly / 重新組裝 / 重新組裝

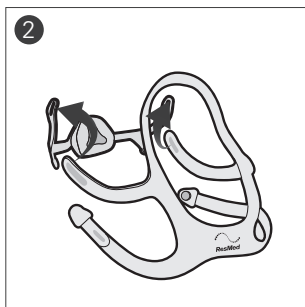
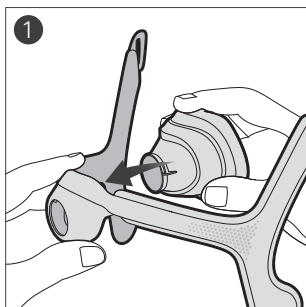

Cleaning your mask at home / 家中清潔面罩須知 /
家中清潔面罩須知

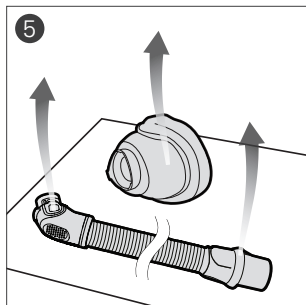
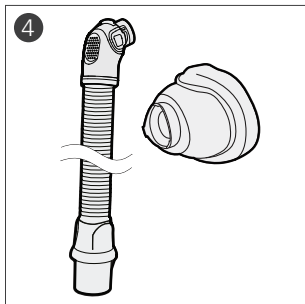
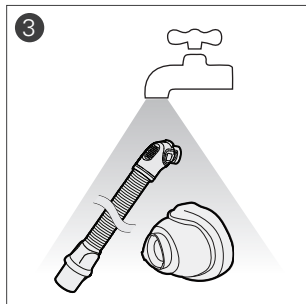
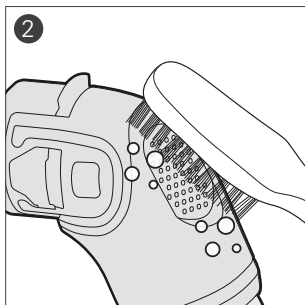
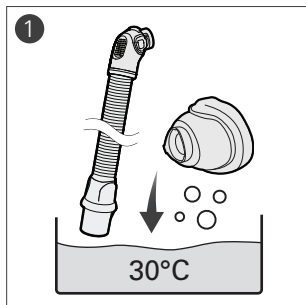

AirFit™ N20

Nasal Mask

Thank you for choosing the AirFit N20. This document provides the user instructions for the AirFit N20 and AirFit N20 for Her masks referred to collectively as AirFit N20 throughout this manual.

Using this guide

Please read the entire guide before use. When following instructions, refer to the images at the front of the guide.

Intended use

The AirFit N20 channels airflow non-invasively to a patient from a positive airway pressure (PAP) device such as a continuous positive airway pressure (CPAP) or bilevel device.

The AirFit N20 is:

- to be used by patients weighing more than 30 kg for whom positive airway pressure has been prescribed
- intended for single-patient re-use in the home environment and multi-patient re-use in the hospital/institutional environment.

WARNING

Magnets are used in the lower headgear straps and the frame of the AirFit N20. Ensure the headgear and frame is kept at least 50 mm away from any active medical implant (eg, pacemaker or defibrillator) to avoid possible effects from localised magnetic fields. The magnetic field strength is less than 400 mT.

Contraindications

Use of masks with magnetic components is contraindicated in patients with the following pre-existing conditions:

- a metallic hemostatic clip implanted in your head to repair an aneurysm
- metallic splinters in one or both eyes following a penetrating eye injury.

GENERAL WARNINGS

- The vent holes must be kept clear.
- The mask should only be used with CPAP or bilevel devices recommended by a physician or respiratory therapist.
- The mask should not be used unless the device is turned on. Once the mask is fitted, ensure the device is blowing air. Explanation: CPAP and bilevel devices are intended to be used with special masks (or connectors) which have vent holes to allow continuous flow of air out of the mask. When the device is turned on and functioning properly, new air from the device flushes the exhaled air out through the mask vent holes. However, when the device is not operating, insufficient fresh air will be provided through the mask, and the exhaled air may be rebreathed. Rebreathing of exhaled air for longer than several minutes can, in some circumstances, lead to suffocation. This applies to most models of CPAP or bilevel devices.
- Follow all precautions when using supplemental oxygen.
- Oxygen flow must be turned off when the CPAP or bilevel device is not operating, so that unused oxygen does not accumulate within the device enclosure and create a risk of fire.
- Oxygen supports combustion. Oxygen must not be used while smoking or in the presence of an open flame. Only use oxygen in well ventilated rooms.
- At a fixed rate of supplemental oxygen flow, the inhaled oxygen concentration varies, depending on the pressure settings, patient breathing pattern, mask, point of application and leak rate. This warning applies to most types of CPAP or bilevel devices.
- The technical specifications of the mask are provided for your clinician to check that they are compatible with the CPAP or bilevel device. If used outside specification or if used with

incompatible devices, the seal and comfort of the mask may not be effective, optimum therapy may not be achieved, and leak, or variation in the rate of leak, may affect the CPAP or bilevel device function.

- Discontinue using this mask if you have ANY adverse reaction to the use of the mask, and consult your physician or sleep therapist.
- Using a mask may cause tooth, gum or jaw soreness or aggravate an existing dental condition. If symptoms occur, consult your physician or dentist.
- As with all masks, some rebreathing may occur at low CPAP pressures.
- Refer to your CPAP or bilevel device manual for details on settings and operational information.
- Remove all packaging before using the mask.
- The mask must be used under qualified supervision for users who are unable to remove the mask by themselves.
- This mask is not for use on patients with impaired laryngeal reflexes or other conditions predisposing to aspiration in the event of regurgitation or vomiting.
- Avoid connecting flexible PVC products (eg, PVC tubing) directly to any part of the mask. Flexible PVC contains elements that can be damaging to the materials of the mask, and may cause the components to crack or break.
- The mask contains an exhaust port safety feature to enable normal breathing. The mask should not be worn if this safety feature is damaged or missing.

Using your mask

When using your mask with ResMed CPAP or bilevel devices that have mask setting options, refer to the Technical specifications section in this user guide for the correct setting.

For a full list of compatible devices for this mask, see the Mask/Device Compatibility List on www.resmed.com/downloads/masks. If you do not have internet access, please contact your ResMed representative.

Fitting

1. Twist and pull both magnetic clips away from the frame.
2. With both lower headgear straps released, hold the mask against your face and pull the headgear over your head.

Headgear check:

Ensure that the ResMed logo on the headgear is facing outwards and is upright when the headgear is put on.

3. Bring the lower straps below your ears, and attach the magnetic clip to the frame.
4. Undo the fastening tabs on the upper headgear straps. Adjust the straps evenly until the mask sits comfortably just over the nose. Reattach the fastening tabs.
5. Undo the fastening tabs on the lower headgear straps. Adjust the straps evenly until the mask is stable. Reattach the fastening tabs.
6. Connect the device air tubing to the short tube. Attach the elbow to the mask by pressing the side buttons and pushing the elbow into the mask, ensuring it clicks in on both sides.
7. Your mask and headgear should be positioned as shown in the illustration.

Adjustment

If necessary, slightly adjust the position of the mask for the most comfortable fit. Ensure that the cushion is not creased and the headgear is not twisted.

1. Turn on your device so that it is blowing air.

Adjustment tips:

- ✓ To resolve any leaks at the upper part of the mask, adjust the upper headgear straps. For the lower part, adjust the lower headgear straps. Adjust only enough for a comfortable seal.
- ✓ The upper strap adjustment is the key to seal and comfort.
- ✓ Do not overtighten the lower straps because they mainly serve to keep the cushion in position.

Removal

1. Twist and pull both magnetic clips away from the frame.
2. Pull the mask away from your face and back over your head.

Disassembly

If the mask is connected to your device, disconnect the device air tubing from the short tube.

1. Undo the fastening tabs on the upper headgear straps. Pull the straps out of the frame.

Tip: Keep the magnetic clips attached to the lower headgear straps to easily distinguish the upper and lower straps when reassembling.

2. Remove the elbow from the mask by pressing the side button and pulling the elbow away.
3. Hold the frame by placing your thumb over the side slot. Pull the cushion away from the frame.

Reassembly

1. Push the cushion into the frame. The frame has a shape that allows you to insert the cushion only one way.
2. With the ResMed logo on the headgear facing outside and upright, thread the upper headgear straps into the frame slots from the inside. Fold them over to secure.

Cleaning your mask at home

It is important to follow the steps below to get the best performance out of your mask.

WARNING

- As part of good hygiene, always follow cleaning instructions and use a mild liquid detergent. Some cleaning products may damage the mask, its parts and their function, or leave harmful residual vapours that could be inhaled if not rinsed thoroughly.
- Regularly clean your mask and its components to maintain the quality of your mask and to prevent the growth of germs that can adversely affect your health.

CAUTION

If any visible deterioration of a system component is apparent (cracking, crazing, tears etc), the component should be discarded and replaced.

Daily/After each use:

Before cleaning, take the mask components apart according to the disassembly instructions.

1. Soak and agitate the cushion, multi-hole elbow and short tube in warm water (approximately 30°C) using a mild liquid detergent for up to 10 minutes.
2. Clean the components with a soft bristle brush, paying particular attention to the small vent holes on the multi-hole elbow.
3. Thoroughly rinse the components under warm flowing drinking quality water.
4. Inspect each component to ensure that they are visually clean and free of detergent residue. If required, repeat washing.
5. Allow the components to dry out of direct sunlight before assembling.

Weekly:

The magnetic clips can be left on for washing.

1. Soak and agitate the separated headgear and frame in warm water (approximately 30°C) using a mild liquid detergent for up to 10 minutes.
2. To rinse the components, repeatedly squeeze them under warm flowing drinking quality water until it is free of detergent residue.
3. Squeeze the components to remove excess water.
4. Allow the components to dry out of direct sunlight before assembling.

Reprocessing the mask between patients

Reprocess this mask when using between patients. Cleaning, disinfection and sterilisation instructions are available on www.resmed.com/downloads/masks. If you do not have internet access, please contact your ResMed representative.

Troubleshooting

Problem/possible cause	Solution
Mask is too noisy.	
Vent is dirty.	Clean the vent according to the instructions.
Mask is incorrectly assembled.	Disassemble the mask, then reassemble according to the instructions.

Problem/possible cause	Solution
Mask is leaking.	<p>Refit or reposition your mask.</p> <p>Readjust the headgear straps to bring the mask closer to the face and improve your seal.</p> <p>Check that your mask is assembled correctly.</p>
Mask leaks around face.	
Mask is not positioned correctly.	Check that the mask size indicator is facing downward on the bottom of the cushion along the bottom of your nose.
Mask may have been fitted incorrectly.	Pull the mask away from your face and reposition, ensuring that the lower corners of the mask fully enclose your nose. If necessary, readjust the headgear straps to keep the mask in the right place.
Cushion may be dirty.	Clean the cushion according to the instructions.
Cushion membrane is creased or folded.	Remove and refit your mask according to the fitting instructions. Ensure that you position the cushion correctly over your nose before pulling the headgear over your head. Do not slide the mask down your face during fitting as this may lead to folding or curling of the cushion.
Mask is not tightened correctly.	<p>Ensure that the headgear straps are not overtightened or too loose. You may find that this mask does not need to be tightened as much as other nasal masks.</p> <p>Check that the headgear is not twisted.</p>
Mask may be the wrong size.	Talk to your clinician.
Mask does not fit properly.	
Mask is incorrectly assembled.	Disassemble the mask, then reassemble according to the instructions.
Mask may be the wrong size.	Talk to your clinician.

Technical specifications

Pressure-flow curve The mask contains passive venting to protect against rebreathing. As a result of manufacturing variations, the vent flow rate may vary.

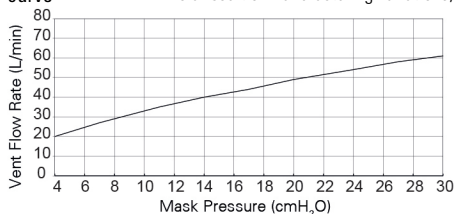

Pressure (cm H ₂ O)	Flow (L/min)
4	20
7	27
11	35
14	40
17	44
20	49
24	54
27	58
30	61

Dead space information Physical dead space is the empty volume of the mask to the end of the swivel. Using the large cushions it is 103.3 mL.

Therapy pressure 4 to 30 cm H₂O

Resistance Drop in pressure measured (nominal)
at 50 L/min: 0.3 cm H₂O
at 100 L/min: 1.3 cm H₂O

Environmental conditions Operating temperature: 5°C to 40°C
Operating humidity: 15% to 95% non-condensing
Storage and transport temperature: -20°C to +60°C
Storage and transport humidity: up to 95% non-condensing

Sound DECLARED DUAL-NUMBER NOISE EMISSION VALUES in accordance with ISO 4871. The A-weighted sound power level of the mask is 24 dBA, with uncertainty of 3 dBA. The A-weighted sound pressure level of the mask at a distance of 1 m is 16 dBA, with uncertainty of 3 dBA.

Gross dimensions 339 mm (H) x 291 mm (W) x 162 mm (D)
Mask fully assembled with the short tube assembly and swivel, excluding the headgear

International Commission on Non-Ionising Radiation Protection (ICNIRP)	Magnets used in this mask are within ICNIRP guidelines for general public use.
---	--

Service life	The service life of the AirFit N20 mask system is dependent on the intensity of usage, maintenance, and environmental conditions to which the mask is used or stored. As this mask system and its components are modular in nature, it is recommended that the user maintain and inspect it on a regular basis, and replace the mask system or any components if deemed necessary or according to the 'visual criteria for product inspection' in the 'Cleaning your mask at home' section of this guide. Refer to the 'Mask components' section of this guide for information of how to order replacement parts.
---------------------	---

Mask setting options	For AirSense, AirCurve and S9: Select 'Pillows'. For other devices: Select 'SWIFT' (if available), otherwise select 'MIRAGE' as the mask option.
-----------------------------	---



Device Setting
Pillows

Notes:

- This product is not made with PVC, DEHP, DBP or BBP.
- This product is not made with natural rubber latex.
- The manufacturer reserves the right to change these specifications without notice.

Storage

Ensure that the mask is thoroughly clean and dry before storing it for any length of time. Store the mask in a dry place out of direct sunlight.

Disposal

This mask does not contain any hazardous substances and may be disposed of with your normal household refuse.

Symbols

The following symbols may appear on your product or packaging:



Catalogue number



Batch code



Humidity limitation



Temperature limitation



Fragile, handle with care



Not made with natural rubber latex



Manufacturer



European Authorised Representative



Keep away from rain



This way up



Nasal mask



Device setting - Pillows



Size - small



Size - medium



Size - large



Indicates a Warning or Caution and alerts you to a possible injury or explains special measures for the safe and effective use of the device



Caution, consult accompanying documents

Consumer Warranty

ResMed acknowledges all consumer rights granted under the EU Directive 1999/44/EC and the respective national laws within the EU for products sold within the European Union.

Warranty information for Australian customers

Our goods come with guarantees that cannot be excluded under the Australian Consumer Law. You are entitled to a replacement or refund for a major failure and for compensation for any other reasonably foreseeable loss or damage. You are also entitled to have the goods repaired or replaced if the goods fail to be of acceptable quality and the failure does not amount to a major failure.

In addition to your rights and remedies under Australian Consumer Law (and any other applicable law), ResMed Pty Ltd ABN 30 003 765 142 of 1 Elizabeth Macarthur Drive, Bella Vista NSW 2153 (ResMed) warrants that your ResMed product will be free from defects in material and workmanship from the date of purchase for the period specified below.

Product	Warranty period
<ul style="list-style-type: none">Mask systems (including mask frame, cushion, headgear and tubing)—excluding single-use devicesAccessories—excluding single-use devicesFlex-type finger pulse sensorsHumidifier water tubs (non-reusable)	90 days
<ul style="list-style-type: none">Batteries for use in ResMed internal and external battery systems	6 months
<ul style="list-style-type: none">Clip-type finger pulse sensorsCPAP and bilevel device data modulesOximeters and CPAP and bilevel device oximeter adaptersHumidifiers and humidifier water tubs (reusable)Titration control devicesResMed Connectivity Module (RCM)	1 year

Product	Warranty period
<ul style="list-style-type: none"> • CPAP, bilevel and ventilation devices (including integrated humidifiers and external power supply units) • Battery accessories • Portable diagnostic/screening devices 	2 years

To make a claim under this warranty you should contact the ResMed accredited outlet from which you purchased your ResMed product or send your claim to ResMed at 1 Elizabeth Macarthur Drive, Bella Vista NSW 2153 (phone number (02) 8884 1000) (email: reception@resmed.com.au). All claims under this warranty must be accompanied by your original receipt.

You will then need to deliver the ResMed product you claim is defective to the ResMed accredited outlet from which you purchased your ResMed product or your closest ResMed accredited outlet at your expense. A similar product will normally be lent to you by your ResMed accredited outlet while your product is assessed.

The product you claim as defective must be delivered from the ResMed accredited outlet to the ResMed Service Centre within the relevant warranty period referred to above. ResMed will not be responsible for the cost of the transport of your ResMed product to the ResMed Service Centre. You must pay any necessary costs to the ResMed accredited outlet. If ResMed determines that your warranty claim is valid, we will return the repaired product, or a replacement product, to your ResMed accredited outlet at ResMed's expense. If ResMed determines that your warranty claim is valid you may claim any reasonable expenses you have incurred in making the claim by posting to us at 1 Elizabeth Macarthur Drive, Bella Vista NSW 2153 a claim in writing attaching original receipts for the expenses claimed. If ResMed determines that your warranty claim is not valid, we will notify your ResMed accredited outlet by providing a quotation of the cost of repair. Your ResMed accredited outlet will then contact you and you will have the option of taking up the quotation offer, valid for 30 days, or have your product returned unrepaired to your ResMed accredited outlet at ResMed's expense.

This manufacturer's warranty is void on product sold, or resold, outside the region of original purchase. Manufacturer's warranty claims on defective product must be made by the initial consumer at the point of purchase or to us directly as specified above.

This warranty gives you specific legal rights. For further information on your warranty rights, contact your local ResMed dealer or ResMed office.

If you are provided with a replacement or repaired product, the warranty continues to apply to the replacement or repaired device but does not continue beyond the original warranty period referred to above.

If you have any questions or would like the address of your nearest ResMed accredited outlet, please contact our friendly customer service consultants.

AirFit™ N20

鼻面罩

感谢您选用 AirFit N20 产品。本文件提供 AirFit N20 和 AirFit N20 for Her 面罩的使用者说明，而在本手册内此两种制品总称为 AirFit N20。

使用本手册

使用前请阅读手册的全部内容。在按照手册的内容进行操作时，请参照本手册的首页图示说明。

设计用途

AirFit N20 通过持续气道正压或双压水平系统之类的气道正压装置，以无创方式向患者提供气流。

本 AirFit N20 是：

- 供体重超过 30 千克、按医嘱须接受气道正压治疗的患者使用；
- 可供一位病人在家中重复使用和供多位病人在医院/诊所中重复使用。

警告

在下部头带和 AirFit N20 的框架使用磁力夹。确保头带和框架与任何正在医用植入物(如心脏起搏器或除颤器)保持至少 50 毫米的距离，避免局部磁场可能产生的影响。磁场强度低于 400 mT。

禁忌症

禁止有以下症状的患者使用有磁性组件的面罩：

- 做过颅内动脉瘤金属血管夹修复手术；
- 眼部遭受过穿刺伤，在一只或双眼留有金属碎片。

一般性警告

- 通气孔上必须无遮盖物。
- 此面罩只能与医生或呼吸治疗师推荐使用的气道正压或双水平装置配合使用。

- 装置启动后才能使用面罩。面罩配戴好后，必须确定装置正在输送空气。说明：气道正压或双水平装置需要配合特殊面罩(或接头)一起使用，这些面罩带有通气孔可以保证空气能持续地排出面罩。当装置启动并工作正常时，来自装置的新鲜空气会通过面罩通气孔将呼出的气体排出面罩。但是当装置不工作时，将无法向面罩提供足够的新鲜空气，呼出的气体将会被再次吸入。重新吸入呼出的气体，如果超过数分钟，则有可能造成患者窒息。此情形适用于大多数型号的气道正压或双水平装置。
- 输送氧气时，须遵循所有安全保护措施。
- 气道正压或双水平装置未运行时，必须关闭供氧气流。只有这样做，未使用的氧气才不会在装置内部聚集，从而产生火灾危险。
- 氧气会助燃。吸烟或面对明火时，严禁使用氧气。仅在通风条件良好的屋内使用氧气。
- 在补充供氧流量固定不变的情况下，由于压力设置、患者的呼吸模式、面罩、配戴位置和泄漏程度的不同，吸入的氧气浓度可能会有所不同。此警告适用于大多数型号的气道正压或双水平装置。
- 面罩的技术规格乃供您的医生检查确定它们可以和气道正压或双水平装置兼容并用。如果未按规格使用，或者和不兼容的装置配用，可能影响面罩的密封性和舒适度，而无法获得理想的治疗效果，漏气或漏气速度异常也可能会影响气道正压或双压水平装置功能。
- 使用面罩后若出现任何不良反应，请停止使用面罩，并咨询您的医生或睡眠治疗师。
- 使用面罩可能会导致牙齿、牙龈或面颊疼痛或加重现有牙齿病症。如果出现这些症状，请向您的医生或牙医询问治疗方法。
- 和所有的面罩一样，气道正压压力低时，可能会出现某种程度的再吸入。
- 有关设定的详细内容与操作信息，请参阅您的气道正压或双水平装置手册。
- 使用面罩前请先除去所有包装。
- 无法自己摘下面罩的使用者，须在合格的监护下使用此面罩。
- 本面罩不能用于喉反射受损或可在反胃或呕吐时出现误吸情况的病人。
- 避免将柔性聚氯乙烯产品(例如柔性聚氯乙烯软管)直接连接到面罩的任何部分。柔性聚氯乙烯包含对面罩原料可能有害的成份，并可能导致组件破裂或碎裂。

- 面罩包含排气口安全功能，使呼吸保持正常。如果此安全功能受损或缺失，不应戴面罩。

使用面罩须知

与附有面罩设定选择的瑞思迈气道正压或双水平装置合并使用面罩时，请参阅此用户指南的技术规格部分，了解正确的安装方法。

如需了解该款面罩的兼容装置的全部清单，请查看本网站 www.resmed.com/downloads/masks 上的面罩/装置清单。如果您无法上网，请与您的瑞思迈销售代表联系。

配戴

1. 从框上扭开并拉出两个磁性夹。
2. 松开头部下部的束带，将面罩按压在脸上，把头带拉过头顶。
头带检查：
请确保头带戴好头带时，头带的瑞思迈标签朝外朝上。
3. 把下部头带从耳朵下方拉出，把磁性夹扣紧到面罩框上。
4. 解开上半部头带的粘扣带。均匀调整头带，直至面罩舒适地放在鼻子上面。重新扣紧粘扣带。
5. 解开下半部头带的粘扣带。均匀地调整束带，把面罩放稳。重新扣紧粘扣带。
6. 解开上部头带的粘扣带。按压两侧的按钮并将弯头推入面罩，确保与两侧连接在一起。
7. 配戴好的面罩和头带的位置如图所示。

调整

如有必要，请微调面罩位置，以最舒适的位置配戴面罩。确保护垫不起褶皱及头带不扭曲。

1. 开通装置，开始传送气流。
调整提示：
 - ✓ 要解决上部面罩的任何泄漏，请调整上部头带。下部头带的问题，请调整下部头带。调整松紧度以舒适的密封为准。
 - ✓ 上部头带调整是密封和舒适的关键。
 - ✓ 不要过紧调整下部头带，因为他们主要用于保持护垫的位置。

取下面罩

1. 从框上扭开并拉出两个磁性夹。

2. 将面罩从脸部拉开并从脑后拿下。

拆卸

如果面罩连接到您的装置，请从短管断开装置空气管。

1. 解开上半部头带的粘扣带。把束带从面罩框中拔出。

提示:将磁性夹安装到下部束带上，以便重新组装时辨别上下部头带。

2. 按压两侧的按钮，并将弯头拉出，即可从面罩上取下弯头。

3. 大拇指按住侧面按钮，扶住框架。把护垫往外拔出面罩框。

重新组装

1. 将护垫插入面罩框架中。只有一种允许您插入护垫的框架形状。

2. 头带上的瑞思迈标志面朝外和朝上，把上部头带从里向外穿过框插口。系好系牢。

家中清洁面罩须知

请务必遵循以下步骤，以便您的面罩发挥最佳性能。

警告

- 作为保持良好卫生的一部份，请遵循清洁说明并使用温和洗涤液。如果不彻底冲洗干净，某些清洁产品可能会损坏面罩及其部件和功能，或者会残留有害残余气体可能被患者吸入。
- 定期清洁面罩及其组件，保持面罩的品质，防止影响身体健康的细菌生长。

注意事项

系统组件若出现明显变坏情形(例如破裂、纹裂或撕裂等)，则应予以抛弃并更换新组件。

每日/每次使用后清洁：

清洁之前，按照拆卸说明拆卸面罩组件。

1. 将护垫、弯头和短管浸泡在温水中（大约 30°C），加入温和的洗涤液，进行搅动，最长浸泡时间为 10 分钟。
2. 使用软毛刷清洁各个组件，特别注意短管上细小的通气孔。
3. 使用饮用水品质的流动温水，彻底冲洗各个组件。
4. 检查每个组件，确保每个组件看上去干净且没有任何洗涤剂残留物。必要时，重复冲洗。
5. 重新组装之前，可以将各个组件放在避光处自然晾干。

每周清洁：

清洗时可留下磁性夹。

1. 将拆开的头带和面罩框架浸泡在温水中（大约 30°C），加入温和的洗涤液，进行搅动，最长浸泡时间为 10 分钟。
2. 冲洗各个组件时，在流动的饮用水品质的温水中，反复挤压组件，直到没有洗涤液残留物为止。
3. 挤压各个组件，去除多余的水分。
4. 重新组装之前，可以将各个组件放在避光处自然晾干。

不同患者共用面罩的再处理方式

病人之间使用时，重新处理此面罩。清洗、消毒与灭菌指示均在 www.resmed.com/downloads/masks 网站提供。如果您无法上网，请与您的瑞思迈销售代表联系。

故障排除

问题/可能原因

解决方法

面罩噪音太大。

通气孔是脏的。

依照说明清洁通气孔。

面罩组装错误。

拆开面罩，然后依照说明重新组合。

面罩漏气。

重新配戴面罩或调整面罩位置。

重新调整头带束带，使面罩更贴近面部，改善密封状态。

检查面罩是否被正确组合。

问题/可能原因

解决方法

面部周围面罩漏气。

面罩位置不正确。

检查鼻子底部护垫下端的瑞思迈标志是否朝下。

可能没有正确配戴面罩。

从面部拉下面罩并重新摆放位置，确保面罩下角全部罩住鼻子。必要时，重新调整头带束带，保持面罩处于正确位置。

护垫可能很脏。

依照说明清洁护垫。

护垫膜有褶皱或折叠。

拿下面罩，然后依配戴说明重新配戴。确定将护垫置于正确位置后再将头带拉过头部。配戴时，别将面罩滑下脸部，因为这么做可能导致护垫折叠或卷起。

面罩没有正确收紧。

确保头带不要过紧或过松。您可能会发现此面罩不像其它鼻面罩那样需要束紧。

面罩尺寸可能不合适。

检查头带没有扭曲。

请咨询您的医生。

面罩配戴不服贴。

面罩组装错误。

拆开面罩，然后依照说明重新组合。

面罩尺寸可能不合适。

请咨询您的医生。

技术规格

气流压力曲线

面罩具有被动通气功能，可防止再吸入。由于生产制造的差异，排气孔流速可能会有差异。

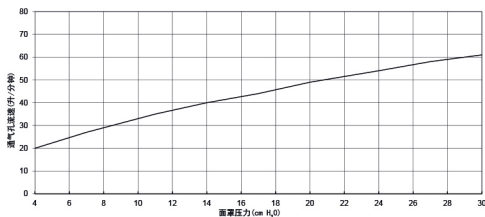

压力 (cm H ₂ O)	气流 (升/分钟)
4	20
7	27
11	35
14	40
17	44
20	49
24	54
27	58
30	61

死腔信息

实质死腔乃是面罩至万向轴末端的空间容积。使用大尺寸护垫，其容积为103.3毫升。

治疗压力

4至30 cm H₂O

阻力

测量到的压力下降(标称值)
处于50升/分钟0.3 cm H₂O
处于100升/分钟1.3 cm H₂O

环境要求

工作温度：5°C 至 40°C
工作湿度：15%至95%，非凝结
存放和运输温度：-20°C 至 +60°C
存放和运输湿度：至95%，非凝结

声音

声明的双数噪音排放值符合ISO 4871标准。面罩的A加权声功率为24分贝，误差为3分贝。在1米的距离内，面罩的A加权声压为16分贝，误差为3分贝。

外部尺寸

339 毫米(高) x 291 毫米(宽) x 162 毫米(厚)

面罩与短管组件和万向轴组装在一起，但不包括头带。

国际非电离辐射保护委员会 (ICNIRP)

面罩内使用的磁块符合ICNIRP准则中供一般公众使用的规定。

使用寿命

AirFit N20面罩系统的使用寿命取决于其使用情况、维护以及面罩使用或存放的环境条件。因为此面罩系统及其组件都是模块化性质，所以我们建议用户定期进行维护和检查，必要时或者根据本指南中“在家清洁您的面罩”章节中的“产品检验视觉标准”，更换面罩系统或任意组件。想要了解如何订购更换部件的信息，请参阅本指南中“面罩组件”章节。

面罩设定选择

AirSense、AirCurve或S9装置：选择“鼻枕”。
其它装置：选择“SWIFT”(若提供)，否则请选“MIRAGE”。



Device Setting
Pillows

备注：

- 本产品不含聚氯乙烯、邻苯二甲酸二异辛酯、邻苯二甲酸二丁酯或者邻苯二甲酸丁苄酯。
- 本品不是用天然乳胶制作。
- 制造商保留在不另行通知的情况下，修改这些规格的权利。

储存

储存前，无论储存时间长短，都需彻底清洁面罩，并保持干燥。面罩需储存于干燥避光处。

废弃

此面罩不含任何有害物质，可按一般家庭废物丢弃处理。

图标

产品上或包装上可能出现如下图标：



目录编号



批次代码



湿度限制



温度限制



易碎物品，小心轻放



不是用天然乳胶制作



制造商



欧洲授权代理



避免雨淋



此面朝上



鼻面罩



设备设置-鼻枕



尺寸-小号



尺寸-中号



尺寸-大号



表明是一个警告或注意事项，提醒您可能会造成伤害的情况或解释安全和有效使用本装置的特殊措施



注意事项，参见随附文件

顾客保证

瑞思迈承认根据欧盟理事指令 1999/44/EG 以及欧盟组织内个别国家法对于在欧盟地区内销售之产品所定的全部消费者权利。

AirFit™ N20

鼻面罩

感謝您選用 AirFit N20 產品。本文件提供 AirFit N20 和 AirFit N20 for Her 面罩的使用者說明，而在本手冊內此兩種製品總稱為 AirFit N20。

使用本手冊

使用前請閱讀手冊的全部內容。在按照手冊的內容進行操作時，請參照本手冊首頁的圖示說明。

設計用途

AirFit N20 透過單陽壓或雙陽壓裝置，以非侵襲性方式向患者提供氣流。

本 AirFit N20 是：

- 供體重超過 30 公斤，按醫囑須接受氣道正壓治療的患者使用。
- 供一位患者在家中重複使用和供多位患者在醫院/診所中重複使用。

警告

在下部頭帶和 AirFit N20 的框架使用磁力夾。確保頭帶和框架與任何正在醫用植入物(如心臟起搏器或除顫器)保持至少 50 毫米的距離，避免局部磁場可能產生的影響。磁場強度低於 400 mT。

禁忌症

禁止有以下症狀的患者使用有磁性組件的面罩：

- 做過顱內動脈瘤金屬血管夾修復手術；
- 眼部遭受過穿刺傷，在一隻或雙眼留有金屬碎片。

一般性警告

- 通氣孔上必須無遮蓋物。
- 此面罩只能與醫生或呼吸治療師推薦使用的單陽壓或雙陽壓裝置配合使用。

- 裝置啟動後才能使用面罩。面罩配戴好後，必須確定裝置正在輸送空氣。解釋：陽壓和雙陽壓裝置需要配合特殊面罩(或接頭)一起使用，這些面罩帶有通氣孔可以保證空氣能持續地排出面罩。當裝置啟動並工作正常時，來自裝置的新鮮空氣會透過面罩通氣孔將吐出的氣體排出面罩。但是當裝置不工作時，將無法向面罩提供足夠的新鮮空氣，吐出的氣體將會被再次吸入。再次吸入吐出的氣體，如果超過數分鐘就可以造成某些患者窒息。此情形適用於大多數型號的單陽壓和雙陽壓裝置。
- 使用補充輸氧時，須遵循所有的預防措施。
- 單陽壓和雙陽壓裝置未運作時，必須關閉供氧氣流，如此未使用的氧氣才不會累積於裝置內部，產生火災危險。
- 氧氣會助燃。吸煙時或者處於明火環境中時，不得使用氧氣。僅在通風條件良好的屋內使用氧氣。
- 在補充供氧流量固定不變的情況下，由於壓力設定、患者的呼吸模式、面罩選擇、配戴位置和漏氣程度的不同，吸入的氧氣濃度可能會有所不同。此警告適用於大多數型號的單陽壓或雙陽壓裝置。
- 面罩的技術規格應由醫生檢查，確定其規格是否與單陽壓或雙陽壓裝置相容。如果未按規格使用，或者和不相容的裝置合用，可能影響面罩的密封性和舒適度，而無法獲得理想的治療效果，漏氣或漏氣速度異常也可能會影響單陽壓或雙陽壓裝置功能。
- 使用面罩後若出現任何不良反應，請停止使用面罩，並諮詢您的醫師或睡眠治療師。
- 使用面罩可能會導致牙齒、牙齦或面頰疼痛或加重現有牙齒病症。如果出現這些病症，請向您的醫生或牙醫詢問治療方法。
- 和所有的面罩一樣，單陽壓壓力低時，可能會出現某種程度的再吸入。
- 有關設定的詳細內容與操作資訊，請參閱您的單陽壓或雙陽壓裝置手冊。
- 使用面罩前請先除去所有包裝。
- 無法自己摘下面罩的使用者，須在合格的監護下使用此面罩。
- 本面罩不能被用於喉反射受損或可在反胃或嘔吐時出現誤吸情況的病人。
- 避免將彈性聚氯乙烯(PVC)產品(例如PVC軟管)直接連接到面罩的任何部份。彈性PVC含有對面罩原料可能有有害的成份，並可能導致組件破裂或碎裂。

- 面罩包含排氣埠安全功能，使呼吸保持正常。若此安全功能受損或缺失，不應戴面罩。

使用面罩須知

與附有面罩設定選擇的瑞思邁單陽壓或雙陽壓裝置合併使用面罩時，請參閱此使用者指南的技術規格部份，了解正確的安裝方法。

如需了解該款面罩的全部相容裝置，請查看瑞思邁網站 www.resmed.com/downloads/masks 面罩/裝置相容清單。如果您無法上網，請與您的瑞思邁銷售代表聯絡。

配戴

1. 從框上扭開並拉出兩個磁性夾。
2. 鬆開頭帶下半部的束帶，將面罩按壓在臉上，把頭帶拉過頭頂。

頭帶檢查：

請確保頭帶戴好頭帶時，頭帶的瑞思邁標籤朝外朝上。

3. 把頭帶下部束帶從耳朵下方拉出，把磁性夾扣緊到面罩框上。
4. 解開上半部頭帶的粘扣帶。均勻地調整束帶，把面罩舒適地放在鼻子上面。重新扣緊粘扣帶。
5. 解開下半部頭帶的粘扣帶。均勻地調整束帶，把面罩放穩。重新扣緊粘扣帶。
6. 將裝置通氣管連接到短管上。按壓兩側的按鈕並將彎頭推入面罩，確保與兩側連接在一起。
7. 配戴好的面罩和頭帶的位置如圖所示。

調整

如有必要，微調面罩位置，以最舒適的位置配戴面罩。確保軟墊不起褶皺和頭帶不扭曲。

1. 開通裝置，開始傳送氣流。

調整提示：

- ✓ 要解決上部面罩的任何洩漏，請調整上部頭帶。下部頭帶的問題，請調整下部頭帶。調整鬆緊度以舒適的密封為準。
- ✓ 上部頭帶調整是密封和舒適的關鍵。
- ✓ 不要過緊調整下部頭帶，因為他們主要用於保持軟墊的位置。

取下面罩

1. 從框上扭開並拉出兩個磁性夾。
2. 將面罩從臉部拉開並從腦後拿下。

拆卸

如果面罩連接到您的裝置，請從短管斷開裝置空氣管。

1. 解開上半部頭帶的粘扣帶。把束帶從面罩框中拔出。

提示：將磁性夾裝到下部束帶上，以便重新組裝時容易辨別上下部頭帶。

2. 按壓兩側的按鈕，並將彎頭拉出，即可從面罩上取下彎頭。
3. 大拇指按住側面按鈕，扶住框架。把軟墊往外拔出面罩框。

重新組裝

1. 將軟墊插入面罩框架中。只有一種允許您插入軟墊的框架形狀。
2. 頭帶上的瑞思邁標誌面朝外和朝上，把上部頭帶從裏向外穿過框插口。系好系牢。

家中清潔面罩須知

請務必遵循以下步驟，以便您的面罩發揮最佳性能。

警告

- 作為保持良好衛生的一部份，請遵循清潔說明並使用溫和洗滌液。如果不徹底沖洗乾淨，某些清潔產品可能會損壞面罩及其部件和功能，或者會殘留有害殘餘氣體可能被患者吸入。
- 定期清潔面罩及其組件，保持面罩的品質，防止影響身體健康的細菌生長。

注意事項

系統組件若出現明顯變壞情形(例如破裂、紋裂或撕裂等)，則應予以拋棄並更換新組件。

每日/每次使用後清潔：

清潔之前，按照拆卸說明拆卸面罩元件。

1. 將軟墊、彎頭和短管浸泡在溫水中（大約 30°C），加入溫和的洗滌液，進行攪動，最長浸泡時間為 10 分鐘。
2. 使用軟毛刷清潔各個元件，特別注意短管上細小的通氣孔。
3. 使用飲用水品質的流動溫水，徹底沖洗各個元件。
4. 檢查每個元件，確保每個元件看上去乾淨且沒有任何洗滌劑殘留物。必要時，重複沖洗。
5. 重新組裝之前，可以將各個元件放在避光處自然晾乾。

每週清潔：

清洗時可留下磁性夾。

1. 將拆開的頭帶和面罩框架浸泡在溫水中（大約 30°C），加入溫和的洗滌液，進行攪動，最長浸泡時間為 10 分鐘。
2. 沖洗各個元件時，在流動的飲用水品質的溫水中，反復擠壓元件，直到沒有洗滌液殘留物為止。
3. 擠壓各個元件，去除多餘的水份。
4. 重新組裝之前，可以將各個元件放在避光處自然晾乾。

不同患者共用面罩的再處理方式

病人之間使用時，重新處理此面罩。清洗、消毒與滅菌指示均在 www.resmed.com/downloads/masks 網站提供。如果您無法上網，請與您的瑞思邁銷售代表聯絡。

故障排除

問題／可能原因

解決方法

面罩噪音太大。

通氣孔是髒的。

面罩組裝錯誤。

面罩漏氣。

依照說明清潔通氣孔。

拆開面罩，然後依照說明重新組合。

重新配戴面罩或調整面罩位置。

重新調整頭帶束帶，使面罩更貼近面部，改善密封狀態。

檢查面罩是否正確組合。

問題／可能原因

解決方法

面部周圍面罩漏氣。

面罩位置不正確。

檢查鼻子底部軟墊下端的瑞思邁標誌是否朝下。

可能沒有正確配戴面罩。

從面部拉下面罩並重新擺放位置，確保面罩下角全部罩住鼻子。必要時，重新調整頭帶束帶，保持面罩處於正確位置。

軟墊可能很髒。

依照說明清潔軟墊。

軟墊膜有繃摺或摺疊。

拿下面罩，然後依配戴說明重新配戴。確保將軟墊置於鼻子的正確位置後再將頭帶拉過頭部。配戴時，別將面罩滑下臉部，因為這麼做可能導致軟墊摺疊或捲起。

面罩沒有正確收緊。

確保頭帶束帶不要過緊或過鬆。您可能發現此面罩不像其它鼻面罩那樣需要束緊。

檢查頭帶沒有扭曲。

面罩尺寸可能不合適。

諮詢您的醫生。

面罩配戴不服貼。

面罩組裝錯誤。

拆開面罩，然後依照說明重新組合。

面罩尺寸可能不合適。

諮詢您的醫生。

技術規格

氣流壓力曲線

面罩具有被動通氣功能，可防止再吸入。由於生產製造的差異，通氣孔流速可能會有差異。

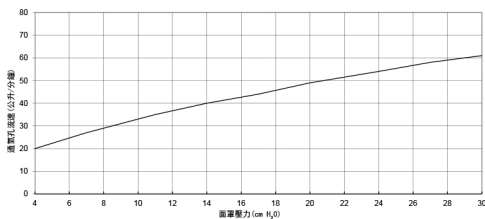

壓力 (cmH ₂ O)	氣流 (公升/分鐘)
4	20
7	27
11	35
14	40
17	44
20	49
24	54
27	58
30	61

死腔訊息 實質死腔乃是面罩至萬向軸末端的空間容積。使用大尺寸軟墊，則其容積為103.3 毫升。

治療壓力 4至30cmH₄O

阻力 測量的壓力下降(標稱值)
處於50公升/分鐘：0.3 cm H₂O
處於100公升/分鐘：1.3 cm H₂O

環境要求 工作溫度：5°C至40°C
工作濕度：15%至95%，非凝結
存放和運輸溫度：-20°C至+60°C
存放和運輸濕度：至95%，非凝結

聲音 聲明的雙數噪音排放值符合ISO 4871標準。面罩的A加權聲功率為24分貝，誤差為3分貝。在1米的距離內，面罩的A加權聲壓為16分貝，誤差為3分貝。

外部尺寸 339毫米 (高) x 291 毫米 (寬) x 162 毫米 (厚)
有短管組件和 萬向軸，但不包括頭帶的面罩全組件

國際非游離輻射防護協會(ICNIRP) 面罩內使用的磁鐵符合國際非游離輻射防護協會(ICNIRP)訂定之公眾使用的規範。

使用壽命	AirFit N20面罩系統的使用壽命取決於其使用情況、維護以及面罩使用或存放的環境條件。因為此面罩系統及其組件都是模組化性質，所以我們建議使用者定期進行維護和檢查，必要時或者根據本指南中「在家清潔您的面罩」章節中的「產品檢驗視覺標準」，更換面罩系統或任意組件。想要瞭解如何訂購更換部件的資訊，請參閱本指南中「面罩組件」章節。
------	---

面罩設定選擇	AirSense、AirCurve或S9裝置：選擇“鼻枕”。 其它裝置：選擇“SWIFT”(若提供)，否則請選“MIRAGE”。
--------	---



Device Setting
Pillows

備註：

- 本產品不含聚氯乙烯、鄰苯二甲酸二異辛酯、鄰苯二甲酸二丁酯或者鄰苯二甲酸丁苄酯。
- 本品不是用天然乳膠製作。
- 製造商保留在不另行通知的情況下，修改這些規格的權利。

儲存

儲藏前，無論儲藏時間長短，都須徹底清潔面罩，並保持乾燥。面罩須儲藏於乾燥避光處。

廢棄

此面罩不含任何有害物質，可按一般家庭廢物丟棄處理。

圖示

您的產品上或包裝上可能出現如下圖示：



目錄編號



批次代碼



濕度限制



溫度限制



易碎物品，小心輕放



不是用天然乳膠製作



製造商



歐洲授權代表



避免雨淋



此面朝上



鼻面罩



裝置設定 - 鼻枕



尺寸 - 小號



尺寸 - 中號



尺寸 - 大號



表明是一個警告或注意事項，提醒您可能會造成傷害的情況或解釋安全和有效使用本裝置的特殊措施



注意事項，參見隨附文件

顧客保證

瑞思邁承認根據歐盟理事指令 1999/44/EG 以及歐盟組織內各自國家法對於在歐盟地區內銷售之產品所定的全部消費者權利。

Mask Components / 面罩组件 / 面罩组件

		AirFit N20	AirFit N20 for Her
A	Elbow and short tube / 弯头和短管 / 彎頭和短管	63565	63565
1	Elbow / 弯头 / 彎頭		
2	Side buttons / 侧按钮 / 側按鈕		
3	Vent / 通气孔 / 通氣孔		
4	Short tube / 侧按钮 / 側按鈕		
5	Swivel / 万向轴 / 萬向軸		
B	Frame / 框架 / 框架	63566	63567
C	Cushion / 护垫 / 護墊	63550 (S) 63551 (M) 63552 (L)	63550 (S) 63551 (M) 63552 (L)
D	Headgear / 头带 / 頭帶	63560 (S) 63561 (Std) 63562 (L)	63558
6	Magnetic clips (2 pack) / 磁性夹 (2包) / 磁性夾 (2包)	63564	63564
7	Lower headgear straps / 下部头带 / 下部頭帶		
8	Upper headgear straps / 上部头带 / 上部頭帶		
A+B+C	Frame system / 框架系统 / 框架系統	63553 (S) 63555 (M) 63556 (L)	63554 (S)

	AirFit N20	AirFit N20 for Her
A+B+C+D		
Complete system / 完整系統 / 完整系統	ANZ: 63521 (M) 63522 (L)	ANZ: 63520 (S)
	APAC: 63524 (M) 63525 (L)	APAC: 63523 (S)
	CHINA: 63529 (M) 63530 (L)	CHINA: 63528 (S)

S: Small / 小号 / 小號

M: Medium / 中号 / 中號

L: Large / 大号 / 大號

Std: Standard / 标准 / 標準



ResMed

AirFit™ N20

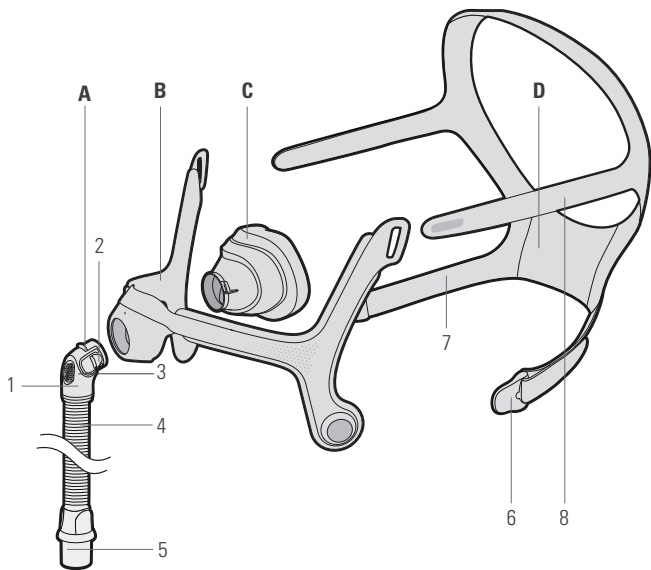

ResMed Pty Ltd

MANUFACTURER 1 Elizabeth Macarthur Drive, Bella Vista NSW 2153 Australia

See [ResMed.com](https://www.ResMed.com) for other ResMed locations worldwide. AirFit, AirSense and AirCurve are trademarks of the ResMed family of companies. For patent and other intellectual property information, see [ResMed.com/ip](https://www.ResMed.com/ip).
© 2021 ResMed. 638246/1 2021-01

[ResMed.com](https://www.ResMed.com)



638246