



ResMed

Power Station II

Battery pack



Click Here To Buy



User guide
English

Power Station II

DC output voltage & DC cables

	24V	26V	DC Cable Part Number
AirSense™ 10	✓		37343
AirCurve™ 10	✓		37343
VPAP™ III ST-A	✓		24959
VPAP™ III ST-A with QuickNav	✓		24959
VPAP™ Auto 25	✓		24960
VPAP™ S, VPAP™ ST	✓		24960
S8™ Auto 25	✓		24960
S9™ Series	✓		24961
Stellar™ Series	✓		24959 (24981 for Stellar™ Mobility bag)
VS III™		✓	24963

English	<p>Notes:</p> <ul style="list-style-type: none"> Not all devices are available in all regions. VPAP III ST-A with QuickNav and VS III are not available in the U.S. To recharge the ResMed Power Station II using an Air 10 power supply unit (supplied with Air 10 devices) or the Air 10 DC converter, an Air 10 power supply unit adaptor is required (part no. 37342). For information on battery run times refer to the Battery/Compatibility List on www.resmed.com.
Français	<p>Remarques :</p> <ul style="list-style-type: none"> Certains de ces appareils ne sont pas disponibles dans tous les pays. La VPAP III ST-A QuickNav et le VS III ne sont pas disponibles aux États-Unis. L'adaptateur du module d'alimentation Air10 (code produit 37342) est nécessaire pour recharger le bloc d'alimentation ResMed Power Station II avec une alimentation Air10 (fournie avec les appareils Air10) ou le convertisseur CC Air10. Pour plus d'informations sur l'autonomie des batteries, veuillez consulter la liste de compatibilité entre les appareils et les batteries disponible sur www.resmed.com.
Español	<p>Notas:</p> <ul style="list-style-type: none"> No pueden obtenerse todos los dispositivos en todas las regiones. El VPAP III ST-A con QuickNav y el VS III no están disponibles en los EE. UU. Para recargar la ResMed Power Station II con una fuente de alimentación Air 10 (suministrada con los dispositivos Air 10) o el transformador de CC Air 10, se necesita un adaptador de la fuente de alimentación Air 10 (n.º de pieza 37342). Para obtener información sobre la duración de las baterías, consulte la Lista de compatibilidad de baterías/dispositivos en www.resmed.com.
Português	<p>Notas:</p> <ul style="list-style-type: none"> Nem todos os dispositivos estão disponíveis em todas as regiões. O VPAP III ST-A com QuickNav e o VS III não estão disponíveis nos EUA. Para recarregar a ResMed Power Station II usando uma unidade de alimentação Air 10 (fornecida com dispositivos Air 10) ou o conversor CC Air 10, é necessário um adaptador da fonte de alimentação Air 10 (peça n.º 37342). Para obter informações sobre a autonomia das baterias, consulte a lista de compatibilidade entre baterias/dispositivos em www.resmed.com.

Intended use

The ResMed Power Station II (RPS II) is an external lithium-ion battery that provides power when mains power is unavailable.

Please read the entire guide before using the RPS II. Refer to the device user guides for intended patients, uses and contraindications associated with CPAP, bilevel and ventilation therapy.

RPS II at a glance

Refer to illustration A.

The RPS II system comprises the following components:

1. Battery
2. Power supply unit adapter
3. Carry bag

Available separately:

4. 90W AC power supply unit or DC converter
5. AC or DC power cord
6. DC output cable
7. Air 10 Power supply unit adaptor

Note: *To recharge the RPS II using an Air 10 power supply unit (supplied with Air 10 devices) or the Air 10 DC converter, an Air 10 power supply unit adaptor is required (part no. 37342).*

Optional accessory:

8. Battery coupler (packed with Velcro™ strap)

Compatible devices and accessories

For a full list of compatible devices for RPS II, see the Battery/Device Compatibility List on www.resmed.com on the **Products** page under **Service & Support**. For a full list of accessories, see the Ventilation Accessories on www.resmed.com on the **Products** page under **Ventilation Devices**. For a list of output voltages and DC cables for your device, see the attached information leaflet, your device user guide, or the Battery/Device Compatibility List on www.resmed.com. If you do not have internet access, please contact your ResMed representative.

For more information on setting up your devices, see your device user guide.

Control panel

Refer to illustration B.

The control panel of your battery includes the following:

- | | |
|---------------------------------|------------------------------------|
| 1. Audible alert mute button | 6. Battery level indicators |
| 2. Charge level check button | 7. Charging indicator |
| 3. DC on/off switch | 8. DC switch/discharging indicator |
| 4. DC input/output port | 9. Voltage output selector switch |
| 5. Audible alert mute indicator | (rear panel) |

Setting up

CAUTION

- Ensure the RPS II and the device are turned off before setting up.
- When the RPS II is plugged to the mains power supply, ensure all cables are properly connected.

Charging the battery

Refer to illustration C.

1. Attach the power supply unit adapter to the DC plug and connect into the battery DC input/output port.
2. Connect the AC or DC power cord to the power supply unit.
3. Plug the other end of the AC or DC power cord into the mains power outlet.

Notes:

- *Charging takes less than 4 hours from 0% battery level to greater than 95%.*
- *To discontinue charging, unplug the power cord from the mains power outlet.*

Providing power to the device

Refer to illustration D.

1. Select the correct output voltage for your device using the voltage output selector from the RPS II rear panel.
2. Connect the appropriate DC output cable into the battery.
3. Connect the other end of the DC output cable into the device.
4. Set the DC on/off switch to on.

Providing backup power to the device (for systems with both AC and DC inputs)

Refer to illustration E.

1. Select the correct output voltage for your device using the voltage output selector from the RPS II rear panel.
2. Connect the appropriate DC output cable into the battery.
3. Connect the other end of the DC output cable into the device.
4. Connect the AC power cord to the rear of the device.
5. Plug the other end of the AC power cord into the mains power outlet.
6. Set the DC on/off switch to on.

Note: *When powering the device regularly check the battery charge level.*

Using two batteries











Refer to illustration F.

1. Place one battery on top of another.
If required, use the Velcro strap to hold the batteries securely.
2. Plug the battery coupler cables into each of the battery DC input/output ports.
The battery coupler cables are marked with '1' (primary) and '2' (reserve) labels.
3. When charging two batteries, attach the power supply unit adapter to the DC plug and connect the adapter to the battery coupler.
When powering a device, connect the DC output cable of the device to the end of the battery coupler. The primary battery supplies power to the device and the reserve battery takes over when the primary battery is disconnected or discharged.

Indicators

Refer to illustration *B*.

The RPS II provides LEDs to indicate its current operating state.

LED indicator	Status
Battery charge level¹ (B-6)	
 One amber flashing (audible alert beeps continuously)	Less than 5%
 One green flashing (audible alert beeps for 10 sec)	Less than 10%
 One green continuous	10% to 40% (approximate)
 Two green continuous	40% to 65% (approximate)
 Three green continuous	65% to 90% (approximate)
 Four green continuous	Greater than 90% (approximate)
Charging (B-7)	
 Flashing green	Charging
 Constant green	Fully charged
DC on/off (B-8)	
 Flashing blue	RPS II turned on but not discharging
 Constant blue	RPS II turned on and discharging
Audible alert mute (B-5)	
 Flashing blue	Not discharging and mute is active
 Constant blue	Discharging and mute is active

¹ When setting the DC on/off switch, the charge level indicator may fluctuate between different levels.

To check the battery charge level, press the charge level check button (B-2) on the control panel. The number of green LEDs indicates the approximate charge level.

To mute the alert, press the audible alert mute button (B-1). To permanently mute, press and hold the audible alert mute button (B-1) for 5 seconds. To deactivate, press the audible alert mute button (B-1) when the mute is still active.

Using humidifiers

With the exception of AirSense 10, AirCurve 10, S9 and H5i™, when a device integrated with a humidifier is not connected to the mains power supply, the humidifier will only operate in passive unheated mode despite the warm-up message appearing on the device. When the device is connected to the mains power supply, it will return to active heated mode.

AirSense 10, AirCurve 10, S9 and H5i devices operate normally in active heated mode when connected to the battery or to the mains power supply.

Cleaning and maintenance

WARNING

Do not immerse the RPS II in water, and do not use liquids to clean any part of the product.

1. Disconnect the battery from the power supply unit and the device. Remove all cables.
2. Wipe the exterior of the battery with a clean cloth.

Storing

CAUTION

Batteries must be charged to 100% indicated by four green LEDs and switched off before storing. You must recharge the batteries to 100% again after six months of storage. When not in use, all Lithium-Ion batteries self-discharge over time. If not periodically recharged (ie, every six months), the RPS II will eventually self-discharge to the point that it can no longer be recharged. If this occurs the RPS II is no longer usable and is unrecoverable.

Store the RPS II in a cool, dry place.

***Note:** A fully charged battery when left switched on, self-discharges to 0% of full capacity within four weeks of storage. When switched off, the battery self-discharges to 0% of full capacity within six months of storage.*

Servicing

The RPS II is intended to provide safe and reliable operation when used and maintained in accordance with the instructions provided by ResMed. There is no servicing necessary during the lifetime of the battery.

The service life of the RPS II exceeds 500 recharge cycles. After 500 recharge cycles, the battery will last about 60% of the time from its original condition. A full charge in an older battery will not last as long as in a new battery. ResMed recommends that the RPS II be tested for battery duration regularly. As with all electrical equipment, if any irregularity becomes apparent, you should exercise caution and contact an authorized ResMed service representative.

Traveling

Consult with your carrier if you intend to take the battery on board with your device.

Troubleshooting

If there is a problem, try the following suggestions. If the problem cannot be solved, contact your equipment supplier or ResMed. Do not attempt to open the battery.

Problem/Possible cause	Solution
Device is not running	
Power connections are disrupted.	Check all cables and connect them as described in Setting up.
RPS II is discharged.	Connect the device to the mains power supply and recharge the RPS II.
RPS II is off.	Set the DC on/off switch to on.
Incorrect output voltage selected.	Select the correct output voltage for your device using the output voltage selector switch from the RPS II rear panel. <i>Note: For a list of output voltages and DC cables for your device, see the attached information leaflet, your device user guide, or see the Battery/Device Compatibility List on www.resmed.com.</i>
RPS II sounds an audible alert continuously and an amber LED is flashing	
The battery charge level is less than 5%.	Press the audible alert mute button to mute the alert. Recharge the battery as soon as possible.
RPS II sounds an audible alert for 10 seconds and a green LED is flashing	
The battery charge level is below 10%.	Recharge the battery as soon as possible.
Charging stops before completion	
When charging the battery inside the RPS II carry bag, the ambient temperature is warmer than 95°F (35°C).	Remove the battery from the RPS II carry bag or charge the battery where the ambient temperature is cooler than 95°F (35°C).
Battery turns off and stops powering device	
When the battery is in the RPS II carry bag, the ambient temperature is warmer than 95°F (35°C).	Remove the battery from the RPS II carry bag or power the device where the ambient temperature is cooler than 95°F (35°C).
Battery charge level indicator is inaccurate	
Ambient temperature is at extreme condition [eg, 23°F (-5°C), 104°F (+40°C)].	Recharge the battery as soon as possible to ensure adequate capacity.

Technical specifications



















Battery technology	Lithium ion
Capacity	< 100 Wh (97 Wh)
UN classification	UN3481 (lithium-ion batteries packed with equipment)
AC power supply	Input range 100–240V, 50–60Hz, 1.0-1.5A Nominal for aircraft use 110V, 400Hz
DC converter	Input range 12V / 24V, 13A / 6.5A
Battery output voltage	(24V / 26V) ± 0.5V, 90W continuous
Power supply unit output current (rated)	3.75 A
Battery output current (rated)	3.75 A / 3.46 A
Standby current	< 100 µA
Protection	Overcharge, overdischarge, excess current, short circuit, high temperature
Dimensions (L x W x H)	9.1" x 5.0" x 1.0" (230 mm x 126 mm x 26 mm)
Battery weight	2.0 lb (0.9 kg)
System weight	5.1 lb (2.3 kg)
Minimum life cycle	≥ 500 cycles at 73°F (23°C) to 60% capacity
Operating conditions	
Charging	41°F to +104°F (5°C to 40°C); 5–85% maximum humidity
Discharging	23°F to +104°F (-5°C to 40°C); 5–85% maximum humidity
Transport/storage conditions	-4°F to +113°F (-20°C to +45°C); 5–85% maximum humidity
Operating/storage air pressure	600 hPa to 1100 hPa
Aircraft use	Product meets the Federal Aviation Administration (FAA) requirements (RTCA/D0-160, section 21, category M) for all phases of air travel.
Recharge time	< 4 hrs at full level
Electromagnetic compatibility	Product complies with all applicable electromagnetic compatibility requirements (EMC) according to IEC60601-1-2, for residential, commercial, and light industry environments. Information regarding the electromagnetic emissions and immunity of these ResMed devices can be found on www.resmed.com , on the Products page under Service and Support. Click on the PDF file for your language.
IEC 60601-1 classification	Class II (double insulation) and/or Internally Powered Equipment, IP21 (IP20 while charging), Continuous Operation (from mains), Limited Operation (from battery), Equipment not suitable for use in the presence of a flammable anaesthetic mixture with air or with oxygen or nitrous oxide.
Battery run time	> 8 hrs at average device settings ¹ For more information, see the Battery/Device Compatibility List on www.resmed.com .

¹ Using 15 cm H₂O (IPAP), 5 cm H₂O (EPAP), and 15 BPM (Respiratory Rate). Not applicable to devices when using heated humidification and heated tubing.

Note: The manufacturer reserves the right to change these specifications without notice.

Symbols

The following symbols may appear on the device or packaging:

 Attention, consult accompanying documents;  Read instructions before use; IP21 Drip proof; IP20 No protection; IPX0 No protection;  Class II equipment;  European RoHS;  Batch Code;  Serial number;  Catalogue Number;  Maximum humidity;  Temperature limitation (storage and transport);  Battery charge level;  Audible alert mute;  DC input/output;  DC on/off;  Do not use if package is damaged;  Canadian Standards Association;  Manufacturer;  Keep dry;  European Authorized Representative;  Prescription only (In the US, Federal law restricts these devices to sale by or on the order of a physician).

Disposal

Disposal of the battery and the power supply unit should be carried out in accordance with applicable national laws and regulations. If you need information on these disposal systems, please contact your local waste administration. If you require information on collection and disposal of your ResMed device please contact your ResMed office, local distributor or go to www.resmed.com/environment.

General warnings and cautions

WARNINGS

- Lithium ion batteries have built-in safety protection circuits, but can still be dangerous if they are not used correctly. Damaged batteries can become inoperative or catch fire.
- Due to risk of fire or electric shock:
 - do not place the RPS II near open fire or heaters.
 - do not expose the RPS II to direct sunlight or heat (for example behind a car window).
 - do not expose the RPS II to water, rain or high moisture levels.
 - do not short-circuit the RPS II.
 - do not use a damaged RPS II.
 - do not open the RPS II, AC charger or the DC converter.
- Make sure to revert to AC power when the remaining capacity of RPS II and/or device internal battery is low.
- Make sure to periodically recharge the battery due to effects of self-discharging.
- As the battery ages, the available capacity decreases. When the remaining battery capacity is getting low, do not rely on the RPS II as the primary supply.
- Ensure the internal battery of any connected device is kept charged up to provide backup power in the event of loss of power from RPS II.
- Only use a supplied ResMed 90W AC power supply unit or DC converter for charging the RPS II.

- Explosion hazard—do not use in the vicinity of flammable anesthetics.
- The RPS II system is not intended for use by persons (including children) with reduced physical, sensory or mental capabilities, or lack of experience and knowledge, unless they have been given supervision or instruction concerning use of the RPS II system by a person responsible for their safety.
- Children should be supervised to ensure that they do not play with the RPS II system.
- Care should be taken to keep the power supply unit adapter dry. The RPS II system, while connected to a device and discharging, is rated to IP21 (Drip proof) according to IEC60529. When charging, the RPS II system is rated to IP20 (No protection) due to the power supply unit adapter which is rated to IP20. The AC power supply, RPS II battery and DC converter are rated to IP21.

CAUTIONS

- Avoid hard, physical impact on the battery.
- Before using for the first time, ensure that the RPS II and its components are in good condition and operational. If there are any defects, the system should not be used.
- The RPS II is to be used only in accordance with the intended use stated in this guide. Damage to equipment or injury can result from modifications to the equipment or operation.
- Always fully charge the RPS II before use, or before relying as a backup power.
- Monitor the charge level of the RPS II. When the charge level is low, ensure that continuity of power can be maintained.
- When in use, always plug the cable from the RPS II into the device. Keep the RPS II power switch turned on to ensure it can provide backup power.
- When transporting, turn off the RPS II, unplug all cables, and pack in the carry bag.
- Medical electrical equipment requires special precautions regarding EMC and needs to be installed and operated according to the information provided in this user guide. Portable and mobile communications equipment can affect medical electrical equipment. If EMC interference is observed, for example static on radios, move the RPS II away from other equipment.

Note: The above are general warnings and cautions. Specific warnings, cautions, and notes appear with the relevant instructions in the guide.

Limited warranty

ResMed Ltd (hereafter 'ResMed') warrants that your ResMed product shall be free from defects in material and workmanship from the date of purchase for the period specified below.

Product	Warranty period
<ul style="list-style-type: none">• Mask systems (including mask frame, cushion, headgear and tubing)—excluding single-use devices• Accessories—excluding single-use devices• Flex-type finger pulse sensors• Humidifier water tubs	90 days
<ul style="list-style-type: none">• Batteries for use in ResMed internal and external battery systems	6 months
<ul style="list-style-type: none">• Clip-type finger pulse sensors• CPAP and bilevel device data modules• Oximeters and CPAP and bilevel device oximeter adapters• Humidifiers and humidifier cleanable water tubs• Titration control devices	1 year
<ul style="list-style-type: none">• CPAP, bilevel and ventilation devices (including external power supply units)• Battery accessories• Portable diagnostic/screening devices	2 years

This warranty is only available to the initial consumer. It is not transferable.

If the product fails under conditions of normal use, ResMed will repair or replace, at its option, the defective product or any of its components.

This limited warranty does not cover: a) any damage caused as a result of improper use, abuse, modification or alteration of the product; b) repairs carried out by any service organisation that has not been expressly authorized by ResMed to perform such repairs; c) any damage or contamination due to cigarette, pipe, cigar or other smoke; and d) any damage caused by water being spilled on or into an electronic device.

Warranty is void on product sold, or resold, outside the region of original purchase.

Warranty claims on defective product must be made by the initial consumer at the point of purchase.

This warranty replaces all other expressed or implied warranties, including any implied warranty of merchantability or fitness for a particular purpose. Some regions or states do not allow limitations on how long an implied warranty lasts, so the above limitation may not apply to you.

ResMed shall not be responsible for any incidental or consequential damages claimed to have resulted from the sale, installation or use of any ResMed product. Some regions or states do not allow the exclusion or limitation of incidental or consequential damages, so the above limitation may not apply to you.

This warranty gives you specific legal rights, and you may also have other rights which vary from region to region. For further information on your warranty rights, contact your local ResMed dealer or ResMed office.

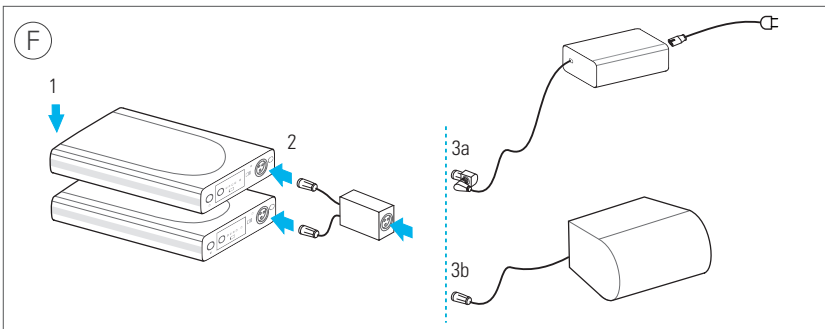
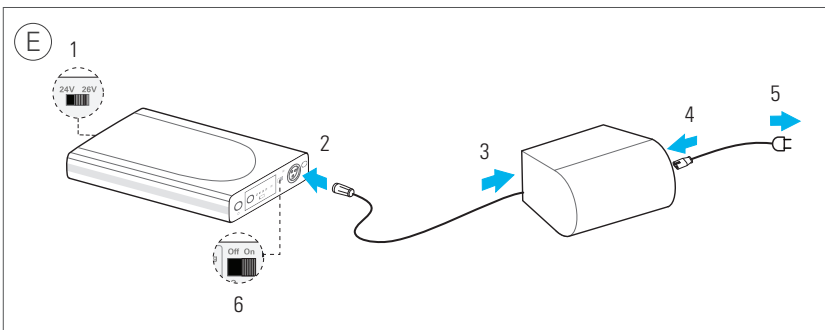
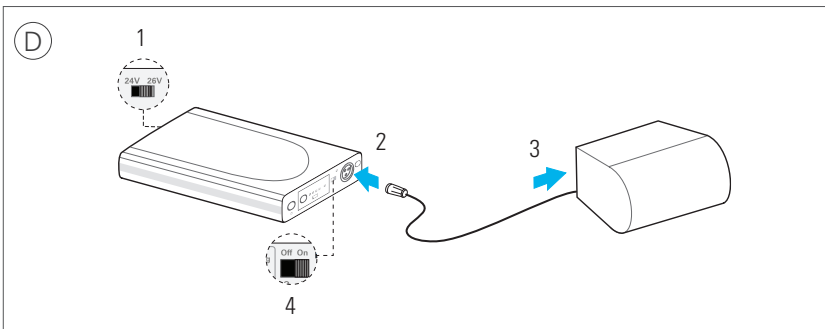



ResMed Ltd

1 Elizabeth Macarthur Drive
Bella Vista NSW 2153
Australia

DISTRIBUTED BY

ResMed Corp 9001 Spectrum Center Boulevard San Diego CA
92123 USA **EC REP** ResMed (UK) Ltd 96 Jubilee Ave Milton Park
Abingdon Oxfordshire OX14 4RW UK

See www.resmed.com for other ResMed locations worldwide. For patent and other intellectual property information, see www.resmed.com/ip. AirSense, AirCurve, H5i, S9, Stellar and VPAP are trademarks and/or registered trademarks of the ResMed family of companies. VSIII is a trademark of ResMed Paris SAS. Velcro is a registered trademark of Velcro Industries B.V.

© 2015 ResMed Ltd. 248818/1 2015-12

ResMed.com



248818